

New York HUNTING & TRAPPING

2023–2024 Official Guide to Laws & Regulations

Volume 17, Issue No. 1, September 2023



See Inside

Highlights of Changes – Page 4

Season Summary – Pages 39-42



Department of
Environmental
Conservation

Remember to Report Your Game Harvest

HuntFishNY Mobile App • 1.866.426.3778 • www.dec.ny.gov

Most regulations are in effect September 1, 2023 through August 31, 2024

Message from the Governor

New York's hunting and trapping traditions date back hundreds of years. While times have changed, these activities are an important link to our past for hundreds of thousands of New Yorkers that bring thousands of visitors to our state each year to experience these traditions.

While wildlife management has changed over the centuries, hunters and trappers have long been integral to conservation of not only the game species they pursue, but the entire spectrum of wildlife diversity and the habitats on which they depend. However, today's challenges are different from those experienced by past hunters and trappers. Climate change, invasive species, and pollution threaten the natural resources we all cherish.

To meet these challenges to our shared environment and our communities, New York is making unprecedented investments in clean air, water, and land. The overwhelming support by New Yorkers resulted in passage of the historic Clean Water, Clean Air and Green Jobs Environmental Bond Act, which will provide generational investments in habitat conservation, species restoration, and further protection of the environment.

The role of hunters as conservationists is not new, but it is as important as ever. I know hunters will continue to be valuable partners with New York State as we implement the Bond Act and many other science driven wildlife management and conservation strategies in the years ahead.

This 2023-24 hunting and trapping guide reflects DEC's sustained efforts to promote and practice sound wildlife management and provide hunters with the information they need to enjoy the upcoming seasons. In addition, DEC wildlife staff and Environmental Conservation Police Officers are always available to answer any questions and clarify requirements before hunters and trappers head out.

Whether the upcoming seasons mean time afield with family and friends, visiting a wild place, harvesting sustainable and wholesome food, or all of the above, take pride in the contributions you and other hunters and trappers make toward conservation while you enjoy New York's outdoors.

Governor Kathy Hochul

Photo by Britta Wareham

Contents

2023–2024 Highlights of Changes	4
DEC Regional Offices/Important Phone Numbers	6

General Hunting Information

Licensing Information	10–13
Special Licenses for Hunters with Disabilities	12
How to Fill Out Your Carcass Tag and Report Your Harvest	13
Hunting Regulations and Hunter Education	14–15
The 4 Rules of Firearm Safety	32
Opportunities for Young Hunters	36–37

Hunting Area Information

Private Lands/State Lands/Other Areas to Hunt	16–17
Public Campgrounds and Licensed Guides	17

Big Game Hunting

General Big Game Regulations	18–21
Tagging, Reporting, and Transporting	18–20
Muzzleloading and Bowhunting	20
Crossbow Hunting Qualifications	23
Big Game Boundary Descriptions and Legal Implements	24
Deer Hunting Season Dates	25
How and When to Use Your Deer Carcass Tags	26
Deer Management Permits	28–29
Hunters: Want Older Bucks in New York?	34
Determining Future Big Game Season Dates	35
Bear Hunting	38

Small Game Hunting

General Small Game Regulations	44–45
Reptiles and Amphibians	44
Possession and Release of Game Birds	44–45
Falconry Seasons	45
Use of Hunting Dogs	45
Small Game Season Dates and Bag Limits	46–47

Turkey Hunting

General Turkey Regulations	48–50
Turkey Season Dates and Bag Limits	49

Migratory Game Bird Hunting

General Migratory Game Bird Regulations	51–52
Snow Goose Conservation Order	51
Migratory Game Bird Season Dates and Bag Limits	53–54
Waterfowl Hunting Zone Descriptions	55–56

Furbearer Hunting

General Furbearer Hunting Regulations	57–58
Furbearer Season Dates and Bag Limits	57
Hunting Furbearers at Night	58

Furbearer Trapping

License Information, Definitions and Trapping Methods	59–60
Body-Gripping Traps and Trigger Specifications	61–62
Furbearer Trapping Season Dates and Bag Limits	63

Environmental Conservation Officers

Q&A	66
Photo Gallery	67
Contact Information	68–69

Maps and Other Info

Regional Maps	70–77
Sunrise/Sunset Table	80



New York State

Kathy C. Hochul, Governor

NYS Department of Environmental Conservation

Basil Seggos, Commissioner

Katherine Petronis, Deputy Commissioner for Natural Resources

Jackie Lendrum, Director, Division of Fish and Wildlife

James Farquhar, Chief, Bureau of Wildlife

Jeremy Hurst, Section Head, Game Management

Katherine Jones, Guide Editor

How to contact us:

NYS Department of Environmental Conservation

Game Management Section

625 Broadway

Albany, NY 12233-4754

Website: www.dec.ny.gov

Division of Fish and Wildlife's Mission:

The mission of DEC's Division of Fish and Wildlife is to serve the interests of current and future generations of New Yorkers by using our collective skills, in partnership with the public, to describe, understand, manage, and perpetuate a healthy and diverse assemblage of fish, wildlife, and ecosystems.

This guide is a summary that is intended for convenience only. For complete references, consult the New York State Environmental Conservation Law and Volume 6 of the Codes, Rules and Regulations of New York State. These are available at:

www.dec.ny.gov/regulations/regulations.html

www.assembly.state.ny.us/leg/ (Environmental Conservation Law)

The advertisements contained herein offset the cost of this guide, are provided for informational purposes only, and do not constitute an endorsement by the New York State Department of Environmental Conservation.



J.F. Griffin Publishing, LLC is proud to print the official *New York Hunting & Trapping Regulations* summary on post-consumer recycled paper.



New York State DEC
Your source
for hunting
and trapping
information!

- Season dates, regulations, and places to hunt can be found on our website.
- Stay informed with email updates; there are more than 135 topics to choose from.



Connect with us on Facebook and Twitter.



Features



9



56



66

- 4 Highlights of Changes for 2023–2024
- 8 Game Harvest Reporting
- 9 A Primer on Hunting with Dogs
- 22 Deer Recovery by Bill Conners
- 23 Crossbow Hunting Information
- 28 Hunter Education: Next Step Courses
- 32 Non-Lead Ammunition Rebate Program: Hunters for Eagle Conservation in New York
- 33 Tree Stand Safety—Hunt Safe, Hunt Smart
- 34 Hunters: Want Older Bucks in New York?
- 39–42 Pull-Out of 2023–24 Hunting and Trapping Seasons Summary
- 43 The Partnership Between Hunter and Hound by John Jarzynski
- 45 Use of Hunting Dogs
- 56 Choosing Duck Season Dates
- 64 Game Recipe: BEAVER-CUE provided by Elevated Wild
- 66 Focus on Law Enforcement

ON THE COVER:

(Left to right) Top right: Jaida M. with dog Sidney; Jarod R. with dog Cooper. Middle row 1: Kelly M. with a Chocolate Lab; Mark C. with dogs Haz and Xo. Middle row 2: Mark C. and Johnathan D. with dog Roxy; McKenna D. with an Irish Setter and a Lab; Ryan M. with dog George; Jackson K. with dog Oakley. Bottom row 3: Susan J. with a Brittany; Selma A. with a Weimaraner; Melissa F. with two Wirehaired Pointing Griffons.



Subscribe now to **CONSERVATIONIST** and save!

- Your guide to New York hunting, wildlife, outdoors, and more.
- Order your FREE issue now! Seven issues for **only \$12**.

Name: _____

Address: _____

City/State/Zip: _____

www.TheConservationist.org or call 800-678-6399 and mention code 89HATG

Or mail this coupon to: **Conservationist, PO BOX 1500, LATHAM, NY 12210**

If you are not satisfied, return the bill marked “cancel” and you will owe nothing.

Highlights of Changes for 2023–2024

Increased Mallard and Canada Goose Opportunities

- The mallard bag limit increased to no more than 4 mallards per day, of which 2 may be hens.
- Canada goose season length and bag limits increased to 45 days with a bag limit of 3 per day in the West Central, East Central, Northeast, Lake Champlain, and Hudson Valley Zones.

For more information on waterfowl seasons go to www.dec.ny.gov/outdoor/28888.html.

Modernized Turkey Hunting Regulations

- Due to advances in shot shell technology, the minimum shot size allowed for turkey hunting (fall and spring) has been reduced from no smaller than #8 to no smaller than #9 shot.
- May 2023 marked the first regulated spring turkey hunting season in Suffolk County (Wildlife Management Unit 1C). The new hunting opportunity will continue in May 2024.

Hunter Education: Next Step Courses

The DEC's Hunter Education Program (HEP) is now offering *Next Step* courses for those who have already completed a hunter education, bowhunter education, or trapper education certification course and want more education and hands-on experience. All *Next Step* courses are free, but registration is required. Please read more about this program on page 28.

Use of Semi-Automatic Rifles for Hunting and Firearm Possession, Storage, and Transport

In 2022, New York State adopted new requirements for the purchase and transfer of ownership of semi-automatic rifles and the purchase, possession, storage, and transport of firearms and ammunition in New York. At press time, additional legislation is pending that may affect these requirements. See www.dec.ny.gov/outdoor/hunting.html and gunsafety.ny.gov for more information and guidance about how these laws affect hunters and hunting-related activities.

Non-lead Ammunition Rebate Program

The DEC is partnering with researchers to implement a multiyear study to determine the reduction in eagle deaths resulting from use of non-lead ammunition for deer hunting. Researchers are offering a rebate of up to \$60 for purchase of certified non-lead ammunition. For more information about this program, please refer to page 32.

Reminder: Recent Deer and Bear Hunting Opportunities and Requirements Continue

- 12- and 13-year-old hunters can hunt deer (not bear) with a firearm or crossbow under the supervision of a licensed adult hunter in counties that have passed a local law to participate. Check the DEC website for an updated list of participating counties.
- Holiday Deer Hunt is an extension of the late bow and muzzleloading season for deer in the Southern Zone from December 26 through January 1.
- Daily hunting hours for deer and bear are 30 minutes before sunrise until 30 minutes after sunset.
- Hunters must wear a fluorescent orange/pink hat or vest when hunting deer or bear with a firearm. See page 18 for details.
- An antlerless-only deer season will occur from Sept. 9–17, 2023, with firearms, crossbows, and vertical bows allowed in WMUs 3M, 3R, 8A, 8F, 8G, 8J, 8N, 9A, and 9F, and vertical bows in WMUs 1C, 3S, 4J, and 8C. Hunters may only use DMPs and DMAP tags during this early antlerless season.

PURCHASE A \$5 HABITAT & ACCESS STAMP TODAY!



This year's Habitat & Access Stamp features the popular opossum! All funds from stamp purchases are used for projects aimed at conserving fish and wildlife habitat and increasing access to public and private lands for outdoor recreational activities.

To make your donation today, go to www.dec.ny.gov/permits/47452.html, visit your local license issuing agent or call 1-866-933-2257.



Williamstown, MA | Birmingham, AL

About This Guide

This high-quality guide is offered to you by the New York State Department of Environmental Conservation through its unique partnership with J.F. Griffin Publishing, LLC.

The revenue generated through ad sales significantly lowers production costs and generates savings. These savings translate into additional funds for other important agency programs.

If you have any feedback or are interested in advertising, please contact us at 413.884.1001 or at www.JFGriffin.com

Graphic Design:

Jon Gulley, Dane Fay, Evelyn Haddad, and Chris Sobolowski



This guide is also available online at

eRegulations.com

Important Numbers

DEC Regions

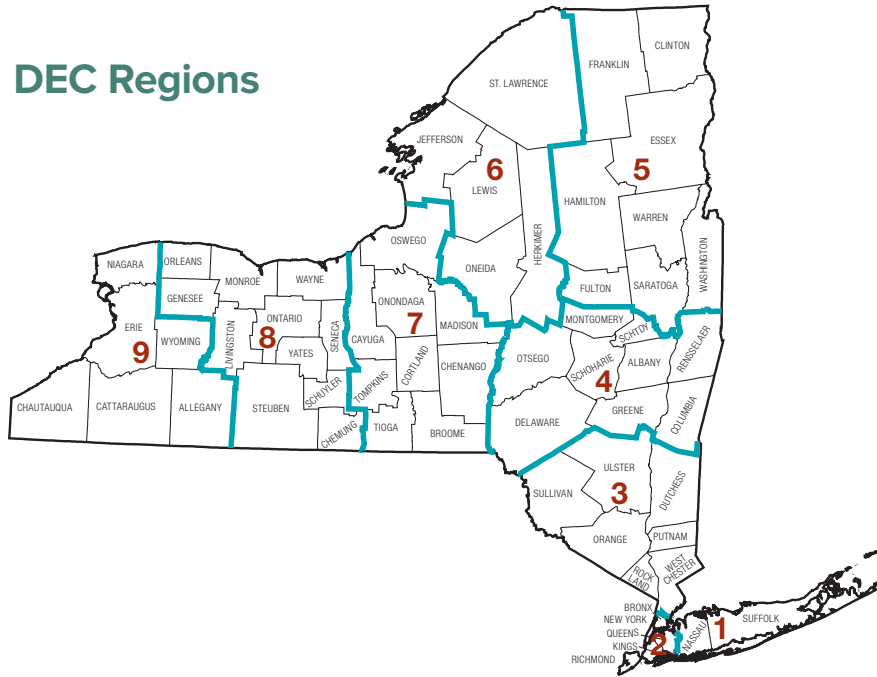

Explore. Learn. Grow.



www.dec.ny.gov
 Search 'Becoming an Outdoors Woman'
 518-402-8963

Hands-on workshops where adult women can learn outdoor skills like how to fish, hunt, shoot, kayak, or backpack in a supportive atmosphere with patient, enthusiastic instructors.

Other Important Numbers

DEC Automated Licensing System	1-866-933-2257 M-F 8AM-5PM, Sat 9AM-5PM
Lifetime License Information	(518) 402-8843
NYC Watershed Hunting Permits	1-800-575-5263
Hunter Ed	1-888-HUNT ED2 (1-888-486-8332)
Deer Management Hotline	1-866-472-4332
Report Game Take via DECALS	1-866-GAME-RPT (1-866-426-3778)
Reporting Banded Waterfowl	www.reportband.gov 1-866-933-2257
Migratory Bird Harvest Information Program (HIP)	decals.licensing.east. kalkomey.com/
Information on NY SAFE Act	1-855-LAW-GUNS (1-855-529-4867)
Forest Rangers	1-833-NYS-RANGERS (1-833-697-7264)
Law Enforcement (ECOs)	1-844-DEC-ECOS (1-844-332-3267)

Important Numbers					
Region	Offices	Wildlife	Law Enforcement	Hunter Ed	Forest Rangers
1	Stony Brook University 50 Circle Rd. Stony Brook, NY 11790-3409	(631) 444-0310	(631) 444-0250	(631) 444-0255	(631) 444-0291
2	1 Hunters Pt. Plaza 47-40 21st St. Long Island City, NY 11101-5407	(718) 482-4922	(718) 482-4885	(631) 444-0255	(631) 444-0291
3	21 South Putt Corners Rd. New Paltz, NY 12561	(845) 256-3098	(845) 256-3013	(845) 256-3063	(845) 256-3026
4	1130 North Westcott Rd. Schenectady, NY 12306-2014	(518) 357-2355	(518) 357-2047	(518) 357-2355	(518) 357-2161
	65561 State Hwy 10, Suite 1 Stamford, NY 12167-9503	(607) 652-7367	—	—	
5	1115 Route 86, PO Box 296 Ray Brook, NY 12977-0296	(518) 897-1291	(518) 897-1326	—	(518) 897-1303
	232 Golf Course Rd. Warrensburg, NY 12885	(518) 623-1240	—	(518) 623-1240	
6	317 Washington St. Watertown, NY 13601-3787	(315) 785-2263	(315) 785-2231	(315) 785-2533	(315) 785-2263
	225 North Main St. Herkimer NY 13350	(315) 866-6330	—	—	
	190 Outer Main St, Suite 103 Potsdam, NY 13676	(315) 265-3090	—	—	
	17893 Game Farm Rd. Dexter, NY 13634	(315) 639-6122	—	—	
7	615 Erie Blvd. West Syracuse, NY 13204-2400	—	(315) 426-7431	—	(607) 753-3095 x.223
	1285 Fisher Ave. Cortland, NY 13045	(607) 753-3095 ext. 247	—	(607) 753-3095 ext. 242 or 247	
8	6274 E. Avon-Lima Rd. Avon, NY 14414-9519	(585) 226-5380	(585) 226-6706	(585) 226-5463	(607) 622-8287
	7291 Coon Rd. Bath, NY 14810-9728	(607) 776-2165	—	—	
9	700 Delaware Ave, Buffalo, NY 14209	(716) 851-7010	(716) 851-7050	—	(716) 372-0645
	182 East Union St., Suite 3 Allegany, NY 14706	(716) 372-0645	—	(716) 372-0645	

Message from the Commissioner

New York is reaping the benefits of our shared efforts to ensure a safe hunting experience for all. The past two years have been the safest for New York hunters, and the 2022 hunting season tied 2021 for the lowest number of hunting-related shooting incidents since record keeping began.

I am proud of the progress of New York's hunter education instructors and the hunting community to make hunting safer than ever. Although even with this success, every incident is still too many, so please remain vigilant and continue to adhere to the hunting safety tenets: point your muzzle in a safe direction, treat every firearm as if it is loaded, keep your finger off the trigger until ready to shoot, be sure of your target and beyond, and always wear hunter orange or pink.

Even though New York hunters have an excellent safety record, elevated hunting incidents, most often involving tree stands, are a growing concern. There is something you can do to prevent severe injuries if you fall from a tree stand or elevated platform — wear and properly use a fall-arrest system and stay connected from the time you leave the ground until you get back down to earth. Remember, a safety harness alone does not protect you if it isn't attached to the tree the entire time you are off the ground.

To hunt safely, be sure your fall-arrest system includes:

1. A vest style full-body harness with shoulder, chest, and leg straps;
2. A strap that attaches to the tree when in the stand;
3. A tether strap that attaches the harness to the tree strap;
4. A "lifeline" to keep you safe while climbing and descending; and
5. A suspension relief strap to be used in the event of a fall.

If you hunt from a tree stand, wear a fall-arrest system, and encourage your friends and family who hunt from tree stands to do the same.

Be safe. Be seen. And good luck this season.

Basil Seggos

Commissioner, New York State Department of Environmental Conservation



Game Harvest Reporting

Hunters are required to report the harvest of deer, bear, and turkey within 7 days of take. You may report your harvest using one of these methods:

- **Online:** www.dec.ny.gov/outdoor/8316.html
- **By phone:** 1-866-GAME-RPT (1-866-426-3778).
- **Game Harvest Mobile App** (see below for details).

DID YOU KNOW?

You may be fined up to \$250 for failing to report your deer, bear, or turkey take.

Take it • Tag it • Report it

Harvest reporting is the **LAW** and necessary for wildlife management!

Report your Game Harvests via Mobile App!

DEC's mobile app, *HuntFishNY* provides hunters with an e-license and game harvest reporting tool. Hunters now have a quick, user-friendly way to:

- gain instant, mobile access to an electronic version of sporting licenses and privileges;
- report the harvest of deer, bear, and turkey on a smartphone immediately while afield, even when out of cellular range;
- view current and past harvest reports
- view PDFs of season maps and sunrise/sunset table
- access an electronic version of regulations guides

The *HuntFishNY* App can be downloaded from the **Apple App store** or **Google Play store**.

NOTE: You will need a DEC Automated Licensing System (DECALS) user name and password in order to access your license documents through the app. If you have not yet created an online user name and password, visit www.dec.ny.gov/permits/6101.html today. Questions? Call our sporting license hotline at 1-866-472-4332.



Camp with us!

NEW YORK STATE Department of Environmental Conservation

at one of the 52 DEC Campgrounds in the Adirondack & Catkill Forest Preserve of New York State

newyorkstateparks.reserveamerica.com

REPORT YOUR HARVEST
1-866-426-3778
HuntFishNY Mobile App
www.dec.ny.gov

TAKE IT
TAG IT
REPORT IT

RECEIVE INFORMATION ABOUT
**HUNTING AND TRAPPING
IN NEW YORK STATE**

Subscribe to DEC Deliveries to receive bi-weekly newsletters from DEC about wildlife biology, management, research, regulations, hunting and trapping.

Subscribe now at www.dec.ny.gov

A Primer on Hunting with Dogs

The New York State Environmental Conservation Law (ECL) allows hunting with dogs throughout the state. Hunting dogs improve your chances of finding and recovering game, but the true advantage of having a hunting dog is having a companion in the field. The bond between hunter and dog is a friendship unlike any other — one that teaches patience, devotion, and allows for serenity in the outdoors. People who hunt with dogs are guided by several important rules and considerations:

- Get permission of all landowners in the area you plan to hunt before heading afield.
- A hunter may not go on posted property, even to retrieve a dog, without landowner permission.
- It is not lawful for a hunter to knowingly release a dog on posted lands.
- In general, dogs are not allowed to run “at large” on lands occupied by deer, but as long as a dog is being used to hunt small game species (this includes game birds as well as raccoons, foxes, bobcats, and coyotes) during an open season under the control of a licensed hunter, it is not considered at-large.
- Some forms of hunting with dogs involve traveling long distances. In these cases, the dogs do not need to be within sight of the hunter, but hunters should avoid releasing the dogs in areas where they may run onto private land on which you do not have permission. Hunters may use radio tracking devices to help them follow their dog.

Hunters should remember that every time you go afield, you are an ambassador of the hunting community:

- Respect our natural resources and be considerate of both the hunting and non-hunting public by obeying all hunting laws and regulations.
- Respect private property owners. Some species, like coyotes, foxes, and raccoons, can travel large distances when being pursued. Get permission from all landowners in any area where your dogs may travel.
- Be a good steward of the resource — information you provide through surveys and harvest reporting is essential for sound game management.



Merganzer, Josh S.'s hunting companion sporting a hunter orange hat to remind others to hunt safe this season

General License Information

Purchasing a License

Hunting, trapping, and fishing licenses can be purchased at over 1,200 agent locations throughout New York State, over the phone via the DEC call center at 1-866-933-2257/M–F, 8AM–5PM, Sat. 9AM–5PM (extended hours Aug 1–Nov 30, M–F 7AM–7PM, Sat 9AM–5PM), and online through DEC’s Automated Licensing System (DECALS) at www.dec.ny.gov/permits/6101.html.

You can also locate a license issuing vendor from the DECALS website. All major credit cards are accepted online and over the phone.

Mandatory Hunter Education

A hunter education course is required for persons who cannot provide proof that they have ever possessed a hunting license. You must be at least 11 years of age to take this class. The general course is an in-person or online course offered by DEC and is a minimum of seven hours in length. Once the course is complete, the individual must have the DEC hunter education certificate added to their DEC licensing profile. This can be done anywhere licenses are sold or by calling 1-866-933-2257. DEC honors hunter education certificates and sporting licenses from all other states and countries that meet IHEA-USA requirements.

Mandatory Bowhunter Education

Hunters wishing to bowhunt for big game must present either:

1. Proof that they successfully completed an approved bowhunter education course (in-person or online). (Note: Approved courses are International Bowhunter Education Program courses or an equivalent course. If in doubt, call toll free — 1-888-HUNT-ED2); OR
2. Proof that they previously held a New York State bowhunting license or stamp issued in 1980 or later; if proof is from prior to 1980, they must take an additional 7-hour minimum bowhunter education course.

Mandatory Crossbow Requirement

Hunters wishing to use a crossbow must complete qualifications in the safe use of hunting with a crossbow and responsible crossbow hunting practices. See page 23 for details.

Residency

To qualify for an annual resident license, a person must live in New York State for more than 30 days immediately preceding the date of application. To qualify for a Lifetime License, a person must live in New York State for at least one year immediately preceding the date of purchase. Land ownership in New York does not make you a resident. Residency is that place where a

Continued on page 12

Licenses, Privileges, and Permits

Type	Age or Special Qualifier	Price
Hunting (Ages 16+) Privileges: Hunt small game species with gun, bow, or crossbow (see page 23). Hunt deer or bear with gun, muzzleloader, bow (with proof of bow education or a bow privilege), or crossbow (see page 23) during the regular season, or hunt with shotgun or muzzleloader during the January firearms season (permit required — see page 18) in Suffolk County (WMU 1C). You may hunt frogs with a valid hunting or fishing license. Qualifications: Hunter Education Certificate OR previous hunting license. Certificates to possess firearms do not qualify. Note: Those less than 18 years of age who are hunting big game for the first time as a holder of a hunting license must be accompanied for the entire season by a parent or legal guardian, or a person 18 years of age or older designated in writing (see permission form on page 37) with at least one year’s experience hunting bear or deer. Accompanist must have a current hunting license and meet all requirements as specified on page 37.	16–69 (NYS Resident)	\$22
	70+ (NYS Resident)	\$5
	Military Disabled ¹	\$5
	Patriot ²	FREE
	Indigenous Peoples ³	FREE
	16+ (Non-Resident)	\$100
Junior Hunting (Ages 12–15)	12–15 (NYS Resident)	\$5
	12–15 (Non-Resident)	\$5
Privileges:		
<ul style="list-style-type: none"> • Ages 12–13: Hunt small game species with gun or bow and deer with gun or crossbow during appropriate seasons when accompanied* by a parent, legal guardian, or person 21 years of age or older with written permission from parent or guardian (see permission form on page 37). Check DEC’s website (www.dec.ny.gov/outdoor/46245.html) for a list of counties where 12- and 13-year-olds can hunt deer with a gun or crossbow and page 37 for details.) • Ages 14–15: Hunt small game with gun, bow, or crossbow (see page 23) when accompanied* by a parent, legal guardian or person 18 years of age or older with written permission from parent/guardian. Hunt deer or bear with a gun, bow (with proof of bow education or a bow privilege), or crossbow (see page 23) during the regular season, or hunt with shotgun or muzzleloader during the January firearms season (permit required — see page 18) in Suffolk County, when accompanied by a parent, legal guardian, or youth mentor 21 years of age or older designated in writing (see permission form on page 37). 		
* Accompanist must have a current hunting license and meet all requirements as specified on page 37.		
Qualifications: Hunter Education Certificate OR previous hunting license (certificates to possess firearms do not qualify). Must be accompanied by parent/legal guardian to purchase. First-time applicants must show proof of age (birth certificate or passport). Junior hunters do not need a Federal Duck Stamp, but are required to register in the NYS Harvest Information Program (www.dec.ny.gov/permits/6405.html) to hunt migratory game birds.		
Bowhunting Privilege (Ages 16+) Privileges: Hunt deer and bear with a bow during bowhunting seasons. Qualifications: Current year NYS hunting license, PLUS acceptable Bowhunter Education Certificate, OR NYS Bowhunting Stamp issued in 1980 or later, OR NYS Junior Bowhunting License issued 1980 or later. Note: To hunt deer or bear with a bow during the regular season, hunter must possess both a valid hunting license and either a current bowhunting privilege or a valid Bowhunter Education Certificate. This includes Westchester and Suffolk counties.	16–69 (NYS Resident)	\$15
	70+ (NYS Resident)	FREE
	Military Disabled ¹	FREE
	Patriot ²	\$15
	Indigenous Peoples ³	FREE
	16+ (Non-Resident)	\$30
Junior Bowhunting (Ages 12–15)	12–15 (NYS Resident)	\$4
	12–15 (Non-Resident)	\$4
Privileges:		
<ul style="list-style-type: none"> • Ages 12–13: Hunt deer and bear with a bow during the bowhunting season or the regular season, or bear during the early bear season when accompanied* by a parent, legal guardian, or youth mentor 21 years or older and designated in writing (see permission form on page 37). Youth hunter will receive a deer of either sex carcass tag for use in the regular season, instead of a regular season buck tag. • Ages 14–15: Hunt deer and bear with a bow during the bowhunting season and the regular season when accompanied* by a parent, legal guardian or youth mentor 18 years of age or older designated in writing (see permission form on page 37). 		
* Accompanist must have a current hunting license and meet all requirements as specified on page 37.		
Qualifications: Current year NYS hunting license, PLUS acceptable Bowhunter Education OR previous Junior Bowhunting License. Must be accompanied by parent/legal guardian to purchase.		
Muzzleloader Privilege (Ages 12+) Privileges: Hunt deer (ages 12+) and bear (ages 14+) with a muzzleloading firearm during muzzleloading season, and the January special firearms season in Suffolk County (WMU 1C; ages 14+). Hunt deer (ages 12+) and bear (ages 14+) with a crossbow (see page 23). Qualifications: Current year NYS hunting license.	12–69 (NYS Resident)	\$15
	70+ (NYS Resident)	FREE
	Military Disabled ¹	FREE
	Patriot ²	\$15
	Indigenous Peoples ³	FREE
	12+ (Non-Resident)	\$30

Licenses, Privileges, and Permits

Type	Age or Special Qualifier	Price
Deer Management Permit Application (Ages 12+) Privileges: Application for up to two antlerless deer tags issued through a random computer selection process. Tags are valid for hunting antlerless deer only (both antlers less than 3" long) in a specified Wildlife Management Unit (WMU). See DMP information on pages 28–29. Application deadline is October 1 annually. Qualifications: Must hold a current year NYS hunting license to apply and pay a non-refundable \$10 application fee. Fee is waived for hunters 12–15 years of age and holders of Lifetime (Sportsman) Licenses purchased prior to October 1, 2009.	12–15 (NYS Resident)	FREE
	16+ (NYS Resident)	\$10
	Military Disabled ¹	\$10
	Patriot ²	\$10
	Indigenous Peoples ³	\$10
	12–15 (Non-Resident)	FREE
	16+ (Non-Resident)	\$10
Turkey Permit (Ages 12+) Privileges: Hunt turkey during fall and spring turkey seasons (see page 45). To hunt turkey, all hunters must possess a turkey permit. There are no exceptions. Qualifications: Current year NYS hunting license. Turkey tags are included with a Lifetime License.	12+ (NYS Resident)	\$10
	Military Disabled ¹	\$10
	Patriot ²	\$10
	Indigenous Peoples ³	\$10
	12+ (Non-Resident)	\$20
Trapping Privileges: Set traps for species during their appropriate seasons (see page 59 for detailed information). Qualifications: Trapper Education Certificate or previous trapping license. See page 37 for additional information on the mentoring program for trappers under 12 years of age.	12–15 (NYS Resident)	\$5
	16–69 (NYS Resident)	\$20
	70+ (NYS Resident)	\$5
	Military Disabled ¹	\$5
	Patriot ²	FREE
	Indigenous Peoples ³	FREE
	12–15 (Non-Resident)	\$5
	16+ (Non-Resident)	\$275

Lifetime Sporting Licenses

The following Lifetime Licenses are available to New York State residents only and may be purchased at all license-issuing outlets throughout New York State. Applicants must prove NYS residency for one year prior to application (see **Residency information** on page 10). For additional information and clarification on Lifetime License sales, contact our License Sales Unit, NYSDEC, 625 Broadway, Albany, NY 12233-4790, call 518-402-8843, or visit www.dec.ny.gov/permits/6099.html. Lifetime License Holders should expect to receive their annual carcass tags in the mail no later than Sept. 1 annually. License Issuing Agents will replace licenses and tags free of charge between Sept. 1 and Nov. 1. After Nov. 1, there will be a replacement charge up to \$15. If you have a lifetime license card, you will only have to replace carcass tags at a fee of \$10.

Lifetime License (Sportsman) (combined hunting and fishing licenses, includes turkey permits):

For a person age 0–4	\$380
For a person age 5–11	\$535
For a person age 12–69	\$765
For a person age 70 or older	\$65

Other Lifetime Licenses/Privileges

Hunting License	\$535
Fishing License (age 0–69)	\$460
Fishing License (age 70 and older)	\$65
Trapping License	\$395
Bowhunting	\$235
Muzzleloading	\$235

¹ **Military Disabled:** Must be a NYS resident and provide a letter from the Department of Veterans Affairs showing a 40% or greater service-connected disability. Once the disability is confirmed and entered, it will stay in your customer profile. **Note:** The first purchase of either a hunting, fishing, or trapping license within a calendar year will cost \$5. Subsequent purchases of these license types within the same calendar year will be free for qualifying customers.

² **Patriot:** Free hunting, fishing, and trapping licenses are available to NYS residents who have the appropriate hunting or trapping education and are active members of the NYS National Guard, US Reserve Forces, or certain members of the US Armed Forces. For more detailed information, visit our website or call 518-402-8843.

³ **Indigenous Peoples:** Recognizing the sovereignty of Indigenous Nations and their governments, tribal members do not need a hunting, fishing, or trapping license from DEC when engaged in these activities on Nation territory. Members of the Shinnecock and Unkechaug Nations, and members of the Haudenosaunee Nations enrolled on reservations wholly or partially in New York State may hunt, fish, and trap off of tribal lands using their tribal identification card or by obtaining a free hunting, fishing, and trapping license from DEC. Licenses can be obtained from participating tribal and nation councils or DEC headquarters in Albany 518-402-8843.

Deer Hunting Privileges and Tags

Resident and non-resident hunter licenses

- **Hunting or Junior Hunting (ages 12–15):** Hunters ages 12 and older will receive a Regular Season Deer Tag and hunters ages 14 and older will receive a Regular Season Deer Tag and Regular Season Bear Tag.
- **Muzzleloading privilege:** You will receive a Bow/Mz Season Either Sex Tag.
- **Junior bowhunting or bowhunting privilege:** You will receive a Bow/Mz Season Either Sex Tag. Junior bowhunters ages 12–13 will

receive an Either Sex Tag and a Bear Tag. Junior bowhunters ages 14–15 will receive an Either Sex Tag. Junior bowhunters may use the Either Sex Deer Tag during the regular season, with bowhunting equipment.

Residents and non-residents must purchase a hunting license to be eligible for bowhunting and muzzleloading privileges. **If you purchase both bowhunting and muzzleloading privileges, you will receive one Bow/Mz Either Sex Deer Tag and one Bow/Mz Antlerless Deer Tag.** Both tags may be used in either season, with the appropriate implement.

Lifetime Licenses and Tags for Young Hunters

Young hunters who hold a lifetime hunting privilege and wish to receive their tags must first take the appropriate hunter safety training course and have it entered in their DECALS profile. To have the course added, please call the DEC call center at 1-866-933-2257 (M–F, 8AM–5PM). Young hunters should take the appropriate training course well in advance of the season to allow adequate time for their tags to be mailed. Tags cannot be obtained from a license-issuing agent.

When purchasing a lifetime license for a child, the purchaser must bring proof of the child's age (e.g., birth certificate or passport) and a copy of the parent's proof of residency.

Remember to Report Your Game Harvest

Visit www.dec.ny.gov/outdoor/8316.html for details. It's the law!

See page 13.

General License Information

Residency continued from page 10

person maintains a fixed, permanent and principal home (regardless of where temporarily located), such as where a person is registered to vote. If under 18, the residence of parents or legal guardian shall be deemed such person's residence. For a complete list of valid residency proof documents please see www.dec.ny.gov/permits/95452.html#Res.

Active members of the U.S. Armed Forces stationed in New York and full-time college students in residence in the state during the school year (proof required) qualify for annual resident licenses.

Minimum Hunting Age

Minors under the age of 12 may not obtain a hunting license or hunt wildlife.

License Year

Licenses and permits are valid from September 1 through August 31.

License Responsibilities

- A license or tag is not transferable and may be used only by the person to whom it was issued (except for Deer Management Permits (DMPs)—see pages 28–29).
- It is illegal to possess another person's license while hunting.
- A license to hunt, trap, or fish does not give the holder any right to go on private property without permission of the landowner.
- You can legally purchase and possess only one hunting license per year.
- Your license must be carried on your person when hunting or trapping.
- It is illegal to refuse to show your license on demand to a law enforcement officer or the owner, lessee, or person in control of the lands (or their designees) while on their property.
- Make sure that your license has all the correct information. Carefully check it immediately after receipt. If you discover an error, have it corrected as soon as possible.



Annie A. with wirehaired pointing griffon, showing off her successful hunt.

Stamps / Donations		
Type	Age or Special Qualifier	Price
Habitat & Access Stamp Donations are used to create or improve fish and wildlife habitat and improve access to those resources for recreational or educational activities.	Any	\$5
Venison Donation Help feed the hungry by supporting NY's venison donation program.	Any	\$1 or more
Federal Duck Stamp Available at most post offices and some sporting goods stores.	16+	\$25
Privileges: Hunt migratory waterfowl. It is not needed for gallinules, coot, crows, rails, woodcock, or snipe. All migratory game bird hunters, including junior hunters, must register with the Harvest Information Program by calling toll free 1-866-933-2257 or www.dec.ny.gov/permits/6405.html . Qualifications: Validated by holder's signature on the face of the stamp. Hunter must also possess a current-year NYS hunting license.		

- Do NOT heat laminate your license. High temperatures will destroy the license and tags and turn them black. If destroyed, there is a fee for replacement.
- Sign the back of your license/privilege panel.

Back Tags

Must be visibly displayed on the middle of your back while hunting, except in the Northern Zone and Catskill Park.

Hunting License Exceptions

All residents must have a valid hunting license in their possession except:

- Resident owners primarily engaged in farming, lessees, and members of their immediate families do not need a hunting license when hunting small game on farmlands they are occupying and cultivating.
- Native Americans living on a reservation do not need a hunting license while hunting on reservation lands.

Free Licenses/ Patriot Licenses

Free hunting, fishing, and trapping licenses are available to members of the Shinnecock and Unkechaug Nations and members of the Six Nations residing on reservations in the state. They must be obtained from some Nations councils or by calling DEC headquarters in Albany 518-402-8843.

Free hunting, fishing, and trapping licenses are also available to NYS residents who have the appropriate hunter education and are active service members of the NYS Guard, US Reserve Forces or certain members of the US Armed Forces. For more detailed information, visit our website or call 518-402-8843.

Lost Licenses

A lost current-year license may be replaced at any license-issuing outlet at a cost of \$5 for a license panel. Big game carcass tag sets or turkey carcass tag sets may be replaced at a cost of

\$10. There is no charge to replace a lost backtag.

Special Licenses for Hunters with Disabilities

Non-ambulatory hunter permit

This permit allows qualified hunters to shoot a firearm from a motorized vehicle (including an off-road vehicle) that has the motor turned off and that is completely off the highway right-of-way.

To qualify for a Non-Ambulatory Hunter Permit, a person must be physically unable to move about except with the use of a mechanized aid such as a wheelchair.

Modified longbow authorization

This authorization allows qualified people to hunt big or small game with a legal bow that is equipped with a device to hold it in a drawn and cocked position. It does not allow for the use of a crossbow.

To qualify for a Modified Longbow Authorization, a person must be permanently physically unable to draw and hold a legal bow.

Modified crossbow permit

This permit allows qualified people to hunt big or small game during bowhunting season with a crossbow that has been specifically modified with a device that only allows it to be discharged (fired) by means of a breath tube. This permit does not allow the use of an unmodified crossbow in place of a bow for the entire bow season.

To qualify for a Modified Crossbow Permit, a person must be permanently physically unable to hold or draw a legal bow or to fire a legal bow that has been modified to hold and release the string.

If a person can pull the trigger on a gun, he or she will not qualify for a Modified Crossbow Permit.

For more information on these permits, write the NYS DEC Special Licenses Unit, 625 Broadway, Albany, NY 12233-4752, email speciallicenses@dec.ny.gov or call 518-402-8985. The application process takes time; write or call well before you intend to hunt.

How To Properly Fill Out Your Carcass Tag and Report Your Harvest

Doc# 23-03-12345678 2023-24

Reg Season Deer Tag
Pete Moss 08/02/1989
 ID: 999999999999 Issued 08/14/2023 12:26 PM

Fill out both sides immediately upon harvest

Kill Info
 Date 11-27-23
 County Greene
 Town Cairo
 WMU 4H

Sex M F
 Antler Pts L 3 R 3

Reg Season
 Bowhunting
 Muzzleloading
 Youth



It's as Easy as 1 - 2 - 3!

- 1 Fill in the date, location, biological, and season information on the front of your tag.
- 2 Mark or cut out month and day of kill AND sign the back of your tag.
- 3 Report your harvest! See details below.

Use pen or permanent marker.

Mark or Cut Out month & day of kill

HuntFishNY
 Check out DEC's mobile app!
NY Fishing, Hunting & Wildlife
 Download FREE from the
 Apple App Store or Google Play!
 Now includes an electronic license & game harvest reporting feature!

For more information on the app & game harvest reporting, visit:
www.dec.ny.gov/outdoor/8316.html
 Report by phone: 866-426-3778

EnCon Officer 247 Dispatch - call 844-332-3267

All Licensees: I hereby affirm under penalty of perjury that information provided on this form is true to the best of my knowledge and belief. False statements are punishable as a Class A misdemeanor pursuant to Section 210.45 of the Penal Law.

Signature Jane Doe Hole

Parents of Junior Licensees must sign and provide supervision.
 Parent's Signature _____

It is against the law to improperly or incompletely fill out your carcass tag.

Hole for attaching to your game

Remember: Take It • Tag It • Report It

3 Reporting Your Game Harvest

- Deer, Bear, and Turkey harvests must be reported within 7 days of take.
- You can report your harvest by phone, online, or through our HuntFishNY mobile app (see page 8 for details).
- Reporting online and through the mobile app is simple, fast, and convenient!
- Visit www.dec.ny.gov/outdoor/8316.html.



Remember to save the bear's skull so DEC can collect a tooth to age the bear.

Information You Will Need When Reporting

CUSTOMER ID #

12 DIGIT DOC #

Doc# 23-03-12345678 2023-24

Reg Season Deer Tag
Pete Moss 08/02/1989
 ID: 999999999999 Issued 08/14/2023 12:26 PM

Fill out both sides immediately upon harvest

Kill Info
 Date 11-27-23
 County Greene
 Town Cairo
 WMU 4H

Sex M F
 Antler Pts L 3 R 3

Reg Season
 Bowhunting
 Muzzleloading
 Youth

Jane Doe
 ID# 314114431020 Valid 09/01/2023 - 08/31/2024
 You must call to report your deer, turkey or bear within 7 days of take.
 To report Call Toll-free : 1-866-426-3778(GAMERPT) or visit www.dec.ny.gov

Date of Kill Reported

DMP Deer Tag-4H 23-04-12345 8

Reg Season Deer 23-03-87654321 11-27-23

Bear Tag 23-02-12345689

CORRECT TAG TYPE

- For Spring Turkey:
 - » Spur length (none, less than 1/2", 1/2" or longer)
 - » Beard length (less than 3", 3" or greater but less than 7 1/2", or 7 1/2" or longer.
 - » Estimated weight
- For Fall Turkey:
 - » Remember to save a leg. We will request it to determine age and sex.

If you SEE something, SAY something

Report Poachers and Polluters

Call an Environmental Conservation Officer at
1-844-DEC-ECOS



General Hunting Regulations

The following are general hunting regulations. Specific regulations for various game species are in the Small Game, Big Game, and Trapping sections of this booklet.

Definitions

Air gun—a firearm that uses spring or compressed air (not gunpowder) to propel a single projectile that is .17 caliber or larger and produces a muzzle velocity of at least 600 feet per second. You may use a smooth or rifled bore.

Bow—includes long (stick), compound, or recurve bow.

Crossbow—consists of a bow, a string, and either compound or recurve limbs with a minimum width of 17 inches (tip of limbs, uncocked), mounted on a stock. The stock shall have a trigger with a working safety that holds the string and limbs under tension until released. It shall have a minimum overall length from the butt of the stock to the front of the limbs of 24 inches and be able to launch a minimum 14-inch arrow/bolt, not including the legal arrowhead. It shall have a draw weight of 100 to 200 pounds. Optical sights are allowed on crossbows.

Firearm—all guns, including handguns, rifles, shotguns, muzzleloaders, BB, and pellet guns.

Handgun—is any pistol or revolver intended to be aimed and fired with one hand and having a barrel length not exceeding 16 inches. Possession of handguns in New York State requires a NYS Pistol Permit. New York does not recognize permits issued by other states.

Muzzleloading firearm—is a firearm loaded through the muzzle, shooting a single projectile and having a minimum bore of .44 inch. Scopes or fiber-optic sights may be used at any time. You must possess a New York State Pistol Permit to hunt with a muzzleloading pistol.

Rifle—is a firearm with a barrel length of 16 inches or more with rifling in the barrel that uses metallic cartridges.

Shotgun—is a firearm with a barrel length of 18 inches or more that uses shells that are non-metallic except for the base.

Motor vehicle—means every vehicle or device operated by any power other than muscle power including but not limited to automobiles, trucks, motorcycles, tractors, trailers, motorboats, snowmobiles, and all-terrain vehicles, whether operated on or off public highways.

Public highway—means any road maintained by a state, county, or town. A private road is one maintained by a person or corporation.

To hunt—means to pursue, shoot, kill, or capture (other than trap) wildlife and includes all lesser acts that disturb or worry wildlife, whether or not they result in taking. Hunting also includes all acts to assist another person in taking wildlife.

Be Safe — Be Seen

- Assume every gun to be loaded.
- Control the muzzle, point in a safe direction.
- Keep finger off the trigger until firing.
- Be sure of your target and beyond.
- Wear hunter orange or pink.

To take—means to pursue, shoot, hunt, kill, capture, trap, snare, or net wildlife and game—and all lesser acts that disturb or worry wildlife—or to place or use any net or other device commonly used to take wildlife.

To trap—means to take, kill, or capture wildlife with traps, deadfalls, and other devices commonly used to take wildlife, including the shooting or killing of lawfully trapped animals. It also includes all related activities such as placing, setting, staking, or checking traps, or assisting another person with these activities.

Manner of Taking

It is illegal to take or hunt wildlife:

- While in or on a motor vehicle (except by special permit—see page 12)
- With the aid of a vehicle's lights
- On or from any public road
- With any firearm equipped with a silencer
- With any firearm which continues to fire as long as the trigger is held back (an automatic firearm)
- With any semi-automatic firearm with a capacity to hold more than 6 rounds, except:
 1. Firearms using .22 or .17 caliber rimfire ammunition, or
 2. Firearms altered to reduce their capacity to no more than 6 shells at one time in the magazine and chamber combined, or
 3. Autoloading pistols with a barrel length of less than 8 inches
- With a spear
- With a bow equipped with any mechanical device which is attached to the bow (other than the bowstring) for drawing, holding, or releasing the bowstring except for a person with a physical disability in possession of a Modified Longbow Authorization (compound bows are legal)
- With a spear gun or modified crossbow except for a person with a physical disability in possession of a Modified Crossbow Permit
- With an arrow with an explosive head or shaft
- With any device designed or intended to deliver drugs to an animal

Baiting—It is illegal to hunt with the aid of bait or over any baited area when hunting big game, upland game birds, turkey, or waterfowl.

Fish—Crossbows may not be used to take carp or any other fish.

Spotlighting

You may use lights to observe wildlife under the following conditions:

- You are not within 500 feet of a home or farm building, unless you have permission from the

owner or lessee (when looking for deer or bear)

- While in or on a motor vehicle and operating a light and no person has a firearm, bow, or crossbow, or if:
 - » the implement is taken down, or
 - » the implement is securely fastened in a case, or
 - » the implement is locked in the trunk of the vehicle, or
 - » the implement is a handgun

For information on hunting furbearers at night, see page 58.

Possession of Firearms and Crossbows

During the open season for deer, it is illegal to:

- Possess shotgun shells loaded with slug or ball, unless holding a valid license (including carcass tags) or permit to take deer or bear, or
- Possess a rifle larger than a .22-caliber rimfire in areas where rifles are banned for taking deer. A rifle larger than .22-caliber rimfire means a rifle chambered for a rimfire cartridge greater than .22-caliber or any centerfire rifle. Centerfire rifles less than .22-caliber and muzzleloading rifles are legal.

In Westchester County and on Long Island, it is illegal to use any rifle for hunting or to carry one afield. In Suffolk, Nassau, and Westchester counties, it is illegal to use a crossbow to hunt wildlife.

In the Northern Zone, it is illegal to carry a rifle larger than .22 rimfire or a shotgun loaded with slug, ball, or buckshot afield if accompanied by a dog, except when coyote hunting.

Possession of handguns in New York requires a NYS Pistol Permit. New York does not recognize permits issued by other states.

New York State recently adopted legislation governing the purchase or transfer of ownership of semi-automatic rifles. Go to www.dec.ny.gov or <https://safeact.ny.gov/resources-hunters> for more information.

Transportation of Firearms

A person may not transport or possess a shotgun, rifle or crossbow in or on a motor vehicle unless the firearm is unloaded in both chamber and magazine or the crossbow is taken down or unloaded (bolt removed and crossbow uncocked).

A muzzleloader is considered unloaded when the cap is off the nipple, the primer is removed, the primer powder is removed from the flintlock pan, or the battery is removed from an electric-fired muzzleloader.

A crossbow is considered unloaded when the arrow/bolt is removed and the crossbow is uncocked. While legally hunting migratory game birds, a loaded firearm may be possessed in a motorboat not under power or in a motorboat under power only while retrieving dead/crippled birds.

Whenever a gun is in a vehicle and an adult is not present, the gun must be locked in a plastic or metal, hard-sided case or safe and be hidden from view. See www.dec.ny.gov/outdoor/hunting.html for more details about gun transportation.

Discharge of Firearms, Crossbows, and Bows

It is illegal to discharge a firearm, crossbow, or bow:

- So that the load or arrow/bolt passes over any part of a public highway
- Within 500 feet for a firearm, 250 feet for a crossbow, or 150 feet for a bow of any school, playground, or an occupied factory or church
- Within 500 feet for a firearm, 250 feet for a crossbow, or 150 feet for a bow of a dwelling, farm building, or structure in occupation or use unless you own it, lease it, are an immediate member of the family, an employee, or have the owner's consent

You may hunt waterfowl over water within 500 feet of a dwelling or public structure as long as

Hunter Education
Hunter Education Program Requirements All first-time hunters, bowhunters, and trappers must pass one or more courses before they can purchase a license. Traditionally, hunter, bowhunter, and trapper education have been in-person courses taught by trained volunteer instructors certified by DEC. In 2020, DEC began offering an online hunter education course and an online bowhunter education course. Be sure to check the DEC website about the availability of both in-person and online courses.
In-Person Hunter Education Program Courses In-person courses have a field day where new hunters and trappers can get hands-on experience. All in-person courses are free of charge, but space may be limited. As hunting and trapping seasons approach, classes fill quickly. SIGN UP EARLY! All in-person hunter, bowhunter, and trapper education courses require the completion of homework prior to attending the course. Proof of completed homework must be brought to the course. Homework may take several hours to complete, so start it well in advance. Visit www.dec.ny.gov/outdoor/92267.html for more information on materials, including a list of courses and course registration.
Online Hunter Education Program Courses All the requirements to earn a New York State hunter education certificate or a New York State bowhunter education certificate can be met by completing DEC's online courses and passing the exams. Upon passing, you will receive your certificate so you can purchase a hunting license or a bowhunter education certificate that enables you to purchase a bowhunting privilege. An online trapper education course may be available in 2023. There is a fee and you must be a New York State resident to take the online courses. They can be accessed at www.dec.ny.gov/outdoor/92267.html .

neither are within 500 feet in the direction you are shooting.

Protected and Unprotected Wildlife

In New York State, nearly all species of wildlife are protected. Most species, including endangered species, songbirds, hawks, and owls are fully protected and may not be taken. The few unprotected species include porcupine,

red squirrel, woodchuck, chipmunk, English sparrow, starling, rock pigeon, and monk parakeet. Unprotected species may be taken at any time without limit. However, a hunting license is required to hunt unprotected wildlife with a bow, crossbow, or firearm.

Game species may be taken only during their open seasons and as summarized in this guide. Persons taking wildlife on licensed shooting preserves must comply with regulations governing those shooting preserves.

Access to Hunting Areas

Places to Hunt in New York

DECinfo Locator is an interactive map that includes DEC lands with public hunting access and other outdoor recreation information. Go to www.dec.ny.gov/pubs/109457.html.

For additional information about places to hunt in New York, go to www.dec.ny.gov/outdoor/7844.html.

Private Lands

Always ASK the landowner for permission to hunt and trap on private land. If it were your land, how would you want a visitor to act?

- Be courteous — ASK permission well in advance.
- ASK what is permitted. What species can be hunted? Are tree stands allowed?
- ASK if friends can join you.
- Exercise safety—always!
- Thank the landowner.

Many landowners use "ASK permission" stickers on their signs, which show the landowners' willingness to allow access to their lands. Stickers are available for free from your local Regional Wildlife Office (see page 6) or from DEC Central Office, 625 Broadway, Albany, NY 12233-4754. For more information on hunting on private lands, visit our website: www.dec.ny.gov/outdoor/7844.html#Hunting.

Remember: Damaging bark or cutting trees, branches, or plants is illegal without permission of the landowner.

ASK Permission

"ASK Permission" stickers, a brochure explaining the program, Landowner Permission forms, and information about fish and wildlife conservation are available for free from DEC Regional Wildlife Offices or by writing:

NYSDEC, 625 Broadway,
Albany, NY 12233-4754

OR ONLINE
at <https://www.dec.ny.gov/outdoor/7844.html>



Rights of way that cross private property, such as for power lines and railroads, are not public land. Trespassing on these areas without permission from the landowner is illegal.

FWMA Cooperative Areas

Through cooperative agreements under New York's Fish and Wildlife Management Act (FWMA), Cooperative Hunting Areas provide access and management services to privately owned lands in order to increase public hunting opportunities. When using these areas, remember that you are a guest on private property. Littering and other abuses will only result in closure of many excellent hunting areas.

A word about liability

Whether or not the land is posted, New York State General Obligations Law protects landowners from liability for non-paying recreationists engaged in hunting, trapping, and fishing on their property. Because of this protection, recreational liability lawsuits against rural landowners are uncommon. This protection does not apply in cases of willful or malicious failure to guard or warn against dangers.

State Recreation Lands

For information on hunting and trapping opportunities and rules governing the use of state land, contact the regional office for the county where you would like to hunt or trap (see page 6). Wildlife staff can provide information on Wildlife Management Areas (WMAs) and Cooperative Hunting Areas. DEC Forestry staff and Forest Rangers can provide details on State Forest lands and Forest Preserve lands. In some instances, written permission or permits are required to use state lands. These are available from DEC regional offices during normal business hours. For more information on State Recreation Lands, visit: www.dec.ny.gov/outdoor/82098.html.

Motorized access to state lands

DEC has designated routes on state forests, wildlife management areas, forest preserve lands and conservation easement lands for motor vehicle use by people with a qualifying mobility disability. For a list of these opportunities, along with information on how to obtain a motorized access permit, please visit the DEC website at: www.dec.ny.gov/outdoor/2574.html.

Wildlife Management Areas

The Division of Fish and Wildlife manages about 187,000 acres of wildlife management areas (WMAs). These areas are located throughout the state and contain a variety of different types of habitat and wildlife. They are managed primarily for wildlife and wildlife-related public use.

WMAs have specific use regulations in addition to the general use regulations for state land. Hunting, trapping, and fishing are permitted, except as specifically restricted by posted notice.

On wildlife management areas, it is unlawful to:

- Target shoot unless posted as an allowed activity
- Camp without written permission
- Travel off-road by use of motorcycles, motor scooters, mopeds, trail bikes, snowmobiles, or any other motorized vehicle, except as specifically allowed by a permit or posted notice
- Remove, cut, or willfully damage or destroy living vegetation of any kind
- Construct or place a permanent structure, blind, stand, or platform (including placement of nails or other hardware into trees)
- Leave any personal property when exiting the area; tree stands labeled with name and address or DEC ID number may be left overnight, but must be removed at the end of the hunting season
- Enter property posted with "No Trespassing" signs, except with written permission from DEC

For more information on WMAs, go to: www.dec.ny.gov/outdoor/7768.html.

Lands and Forests

The Division of Lands and Forests manages nearly 5 million acres of land, located in almost every county of the state. From the remote locations of the Adirondack and Catskill mountains to the rolling hills of the western part of the state and the forested areas on Long Island, a wide range of hunting and trapping opportunities await the outdoor recreationist.

Forest Preserve Lands

Hunting and trapping are permitted in the Adirondack and Catskill forest preserves. State-owned lands located within these preserves are designated Forever Wild. All state land rules and camping requirements apply to the preserves, as well as additional rules specific to certain areas. Contact the regional DEC office (see page 6) of



**Search & Rescue, Wildfire
Report DEC State Land
Violations or Complaints
833-NYS-RANGERS (833-697-7264)**



IF YOU NEED IMMEDIATE ASSISTANCE, DIAL 911

the county where you would like to hunt or trap for more information. For further information on Forest Preserve lands, please visit the DEC website at: www.dec.ny.gov/lands/4960.html.

Conservation Easement Lands

Conservation easements are tracts of privately owned property on which New York State has acquired certain public recreation rights. These rights are outlined in the easement document as well as in a recreation management plan jointly developed by DEC and the landowner. Public hunting and trapping are allowed on many conservation easements, but due to the individual nature of each property, members of the public wishing to hunt or trap on a given easement are strongly encouraged to contact a local DEC office (see page 6) in the county where the property is located. The office can provide details on how to properly access the property and the hunting and trapping regulations unique to the easement. For further information on DEC held conservation easements, please visit the DEC website at www.dec.ny.gov/lands/41156.html.

State Forest Lands

Outside the Adirondacks and Catskills, State Forest lands are the most common type of state lands. Many recreational activities can be pursued on these lands, including hunting and trapping.

In some instances, permits are required to camp overnight on undeveloped State Forest lands. Unless specifically prohibited, groups of less than 10 people may camp on State Forest lands (other than developed campgrounds and wildlife management areas) for three consecutive nights without a permit. To camp for four consecutive nights or more, a permit must be obtained. Groups of 10 or more people need a permit to camp on such lands for one night. Further information may be obtained from DEC regional offices for the county you want to camp in (see page 6). For further information on State Forest Lands, please visit the DEC website at: www.dec.ny.gov/lands/40672.html.

Remember, it is unlawful to:

- Cut or injure trees (including construction of permanent tree stands, construction of natural blinds, clearing of shooting lanes around portable stands, placement of nails or other hardware into trees, or use of live trees as targets while sighting-in firearms).
- Store personal property. Tree stands or hunting blinds that do not injure a tree, and are properly marked or tagged with the owner's name and address or valid hunting license number, may be placed during the appropriate hunting season, but must be removed at the end of the season.
- Erect, use, or maintain a building or structure.
- Deposit or leave any litter or rubbish.

- Operate a motor vehicle, off maintained roads, except where specifically allowed.
- Operate an all-terrain vehicle (ATV) other than designated by posting or by permit.
- Camp without a permit when a permit is required.
- Possess a rifle, shotgun, or firearm in or upon buildings or grounds used for educational purposes (see Penal Law Section 265.01-a).

State Parks

Many State Parks offer waterfowl, small game, and big game hunting. For more information, contact the appropriate DEC regional office (see page 6) or visit the State Parks hunting website (www.parks.ny.gov/recreation/hunting). Call each State Park to find out specific hunting and access regulations. For a listing of State Parks that allow deer hunting, visit the DEC website at www.dec.ny.gov/outdoor/88898.html.

Other Areas to Hunt

- **Finger Lakes National Forest (federal):** Located east of Seneca Lake in Schuyler and Seneca counties, small and big game hunting opportunities are available. Special hunting permits are not required.
- **Fort Drum Military Base (federal):** Wildlife Management Unit 6H, located in Jefferson and Lewis counties includes over half of the 107,000-acre U.S. Army military installation, which is open to the public for hunting and trapping. See the Fort Drum Fish and Wildlife Management Program website for more information at fordrum.isportsman.net or call 315-772-9303.
- **Montezuma National Wildlife Refuge (federal):** Located at the north end of Cayuga Lake in Seneca county, this site offers small game and waterfowl hunting opportunities. This area is also open for deer hunting on a controlled basis during both the bowhunting and regular seasons. Permits are required. When deer management permit use is allowed, WMU 8J permits are valid. For current information on seasons, permits, maps, and regulations visit Montezuma's website at www.fws.gov/refuge/montezuma/visit-us/activities/hunting.
- **Iroquois National Wildlife Refuge (federal):** Located in Genesee and Orleans counties in western New York, this site offers small game and waterfowl hunting opportunities. This area is also open for deer hunting during both the bowhunting and regular seasons. For further information visit www.fws.gov/refuge/iroquois/visit-us/activities/hunting.
- **Long Island:** For a brochure on areas to hunt and for access permits, write to:
 - » Hunting Opportunities, NYS DEC
SUNY Stony Brook
50 Circle Rd.
Stony Brook, NY 11790-3404

- **New York City Watershed Lands:** The New York City Department of Environmental Protection (DEP) allows trapping, as well as deer, bear, turkey, and small game hunting on specially designated city water supply lands. Hunters and trappers must possess the appropriate, valid New York State sporting license and a valid access permit to hunt or trap on designated hunting and trapping areas on city water supply lands. For more information, including maps, go to www1.nyc.gov/site/dep/recreation/hunting-trapping.page.

DEC Campgrounds

DEC operates 52 public campgrounds in the Adirondack and Catskill parks. Hunting is not permitted within these campgrounds, although some campgrounds allow camping during big game season. Unloaded firearms are allowed on public campgrounds only during the spring and fall hunting seasons. A valid hunting license is needed. Firearms cannot be discharged in the campground or day-use facilities at any time. For more information on DEC's campgrounds, visit www.dec.ny.gov/outdoor/7825.html.

Campgrounds outside the forest preserves are operated by the NYS Office of Parks, Recreation and Historic Preservation (see State Parks).

For all campgrounds, reservations can be made by calling 1-800-456-CAMP or online at newyorkstateparks.reserveamerica.com.

Licensed Guides

For information on licensed professional guides in New York, contact NYS DEC, 625 Broadway, NY 12233-4752, call 518-402-8985, or visit the DEC website at www.dec.ny.gov/permits/30969.html.

Use of all-terrain vehicles (ATVs) and off-road vehicles (ORVs) is restricted on most state land.

Indigenous Nation Territories

Some Indigenous Nations have made provisions for limited public hunting, trapping, and fishing access, while others do not permit non-citizens to hunt, trap, or fish on their land. Check with the respective Nation's office to determine the requirements for hunting, trapping, and fishing within the territory boundaries. A special permit may be required.

To speak with a Forest Ranger regarding specific state lands and regulations, including backcountry camping permits, visit <http://on.ny.gov/NYSForestRangerRoster> for a listing of Forest Rangers by county.



Big Game Hunting

Hunting Hours

Big game hunting hours are 1/2-hour before sunrise to 1/2-hour after sunset (see page 80). Sunday hunting is allowed in all areas of New York. Before hunting on state lands, confirm regulations for the area.

Fluorescent Orange and Fluorescent Pink Clothing Requirements

Any person hunting deer or bear with a firearm or a person who is accompanying someone hunting deer or bear with a firearm shall wear:

1. a minimum total of 250 square inches of solid fluorescent orange or fluorescent pink material worn above the waist and visible from all directions; or
2. a minimum total of 250 square inches of patterned fluorescent orange or fluorescent pink consisting of no less than 50% fluorescent orange or fluorescent pink worn above the waist and visible from all directions; or
3. a hat or cap with no less than 50% of the exterior consisting of solid fluorescent orange or fluorescent pink material and visible from all directions.

Legally Antlered Deer

A legally antlered deer must have at least one antler that is 3" or longer. Antlerless deer are those without antlers (does and fawns) and deer with antlers less than 3" long. Special regulations apply in the Antler Restriction areas. See page 24 for details.

Defining "Early" and "Late" Seasons for Deer and Bear

When you see the term "early" muzzleloader or bowhunting season, it means before the regular season for that particular zone. "Late" means after the regular season for that zone.

Feeding and Baiting Prohibited

Intentional feeding or baiting of deer or bear is prohibited at all times of year. This includes use of mineral blocks or powders. Exempt activities include agricultural plantings, wildlife food plots, and cutting of trees or brush to provide winter forage.

Chronic Wasting Disease (CWD) Import Restrictions

Hunters are prohibited from returning to New York with whole carcasses or intact heads of deer, elk, moose, or caribou that they harvest

anywhere outside of New York. Only the deboned meat, cleaned skull cap, antlers with no flesh adhering, raw or processed cape or hide, cleaned teeth or lower jaw, and finished taxidermy products of CWD-susceptible animals may be brought into New York.

Manner of Taking

Big game may be taken with centerfire rifles, shotguns, handguns, muzzleloading firearms, bows, and crossbows during appropriate seasons and in designated areas (see maps, pages 24 and 25). You may use decoys, calls, and attractant scents to hunt big game.

It is unlawful to:

- Take big game while the deer or bear is in water.
- Possess a firearm of any description when bowhunting or accompanying a person bowhunting during an archery-only season.
- Possess a firearm other than a muzzleloading firearm when hunting deer or bear or when accompanying a person hunting deer or bear during a muzzleloading season.
- Make, set, or use salt licks or other attractants, whether block, liquid, or powder that contains any amount of salt, upon lands inhabited by deer or bear at any time of year.

In addition to the general hunting regulations for manner of take listed on page 14, it is unlawful to hunt big game with:

- Dogs or aircraft of any kind, including drones.
- The aid of a pre-established bait pile.
- A firearm or bow aided by any artificial light or a laser that projects a beam toward the target (use of illuminated reticle scopes, red dot scopes, or illuminated sight pins is allowed, provided no light is projected toward the target).
- An autoloading firearm with a capacity of more than 6 shells (one which requires that the trigger be pulled separately for each shot), except an autoloading pistol with a barrel length of less than 8 inches.
- A firearm using rimfire ammunition.
- A shotgun of less than 20 gauge or any shotgun loaded with shells other than those carrying a single projectile (rifling in the barrel or choke is allowed).
- A bow with a draw weight less than 35 lbs.
- Arrows with barbed broadheads; arrowheads less than 7/8 inches at the widest point or with less than 2 sharp cutting edges.
- Double-barreled muzzleloaders or percussion cap revolvers during the special muzzleloading seasons.
- An air gun or air bow.

Deer Management Focus Area

See www.dec.ny.gov/outdoor/82382.html for information on the Deer Management Focus Area in Tompkins County. Expanded antlerless bag limits and a January antlerless season in this area provide additional opportunities for hunters and help to reduce deer-related conflicts.

Long Island Opportunities

All hunting on state-managed land requires a DEC permit. The archery deer season runs from October through January. There is a January firearms season during which shotguns and muzzleloading firearms can be used. Firearms users must obtain a landowner's endorsement to hunt during this season, and may also need a town permit. For more information on Long Island hunting opportunities visit www.dec.ny.gov/outdoor/8373.html.

Prohibited Sale of Deer or Bear Meat

It is unlawful to sell deer or bear meat. Other than meat, the parts (e.g., hides, skulls, claws, antlers, and taxidermy mounts or rugs) from legally taken and reported deer and bear may be sold. Bear gallbladders and bile shall not be possessed or sold unless a valid bear tag (original or copy) is attached.

Meat Unfit for Consumption

If a deer, bear, or turkey is found to be unfit for human consumption, a special permit may be issued that allows the hunter to take another deer, bear, or turkey, provided the season is still open. The entire animal, including the antlers, must be forfeited to get a permit. A permit will not be issued if the meat is unfit due to hunter neglect. Call a Regional Wildlife office or Law Enforcement office listed on page 6.

Tagging, Reporting, and Transporting

Deer and bear are in legal possession only when tagged with the appropriate carcass tag, valid for that season, implement, and sex of animal. See page 26 for clear tag descriptions.

Hunters who take a deer in remote areas may wish to bone it out and pack out the meat. This is lawful, but you must retain the carcass tag with the boned out meat.

Tagging and Reporting

After killing a deer or bear:

1. Ensure that you select the proper tag for the harvested deer or bear.
2. **Immediately** fill in all information and sign the carcass tag with ink that won't erase.
3. **Immediately** cut or mark the month and date of kill on the tag reverse.
4. Write the date of kill on the report panel. This will help you when reporting a harvest.
5. **Attach the tag** to the carcass upon arrival at your camp, home, or vehicle. You do not need to attach the tag while it is being

Continued on page 18





Big Game Hunting

Continued from page 20

dragged or physically carried from the place of kill to a camp or point where transportation is available.

6. **Report your harvest** online, by phone, or mobile app within 7 days as required by law. See page 8 for details.

After you have used your last deer tag, you may help others hunt deer. You must have your hunting license with you, and you may not shoot or attempt to shoot a deer.

Broadheads for Big Game		
Type	Legal	Illegal
Fixed Blade		
Mechanical Blade (shown in position of being withdrawn from an animal)	 Blades pivot forward (no longer barbed)	 Blades do not pivot (remain barbed)

Transporting

Deer and bear may be transported either inside or outside the vehicle.

- A deer carcass with head and deer carcass tag attached may be transported with the taker in attendance.
- If someone other than the taker is transporting the deer or bear, the taker must attach an additional tag to the carcass and include the names and addresses of both the taker and the transporter. The tag may be handwritten in ink or typed on any paper.
- All portions of deer or bear meat being transported by the taker shall be individually tagged and the tags shall include the name, address, big game DOC #, the date that the portions were cut, and the signature of the taker. Packaged or boxed portions of venison need only one tag and must be labeled "venison" on the outside of the box. If someone other than the taker is transporting the portions, an additional tag signed by the taker with the names and addresses of the consignee and taker are required for each portion.
- Non-resident hunters: if your home state prohibits the importation of whole deer carcasses from New York, you will need to follow the above guidelines for transportation of individual or packaged portions of deer meat while in New York State.

- A deer carcass minus the head may be transported as above, but evidence of the sex of the deer must be intact. The deer carcass tag must be affixed to the carcass, and a tag supplied by the taker must also be attached showing the name and address of the taxidermist where the head was sent.
- Heads of male deer may be transported to a taxidermist only if a tag supplied by the taker is attached bearing the taker's signature, address, big game DOC #, number of points on each antler, and the name and address of the taxidermist.
- The head of a doe with antlers that are 3 inches or more can be removed for mounting. Follow the same procedure that you would use for mounting a buck (see above).

Muzzleloader Hunting

Muzzleloading firearms may be used during the muzzleloader and regular seasons, and during the January Firearms season on Long Island.

- Hunters must possess a current muzzleloader privilege to participate during the muzzleloader seasons.
- The muzzleloader privilege is not needed for hunters to use a muzzleloading firearm during regular seasons.

Hunters can help end hunger in New York State

Each year, DEC partners with Feeding New York State and the Venison Donation Coalition to provide food for those in need. Through a cooperative relationship involving hunters, deer processors, the NYS Dept. of Health, and non-profit organizations like Feeding NYS, the Venison Donation Coalition, and regional food banks, nearly 40 tons of venison are made available each year to families across the state.

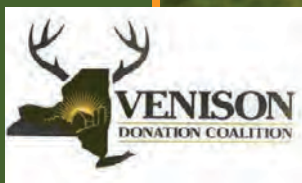

There are many ways a hunter can help feed those less fortunate. You can donate all or part of your deer at a cooperating processor, support your regional food bank monetarily, or you can make a cash donation to support venison donation programs when you purchase your hunting license.

Learn more about these programs by visiting www.dec.ny.gov/outdoor/8351



- Muzzleloaders may not be used in WMUs 3S, 4J, 8C, and may only be used in 1C during the Special Firearms season in January.
- Bow/Muzz either-sex or antlerless-only tags may not be used during the regular seasons, except in WMUs 1C and 3S.
- Hunters participating in the muzzleloader season shall not have in their possession, or be accompanied by a person who has in their possession, a bow or firearm other than a legal muzzleloading firearm or crossbow.

Bowhunting

Bowhunting opportunities include both the bowhunting and regular seasons:

- Hunters must possess a current bowhunting or junior bowhunting privilege to participate during the bowhunting seasons.
- The bowhunting privilege is not required to hunt with a bow during regular seasons, but hunters must possess proof of eligibility (either a valid bowhunter education certificate or prior bowhunting license).
- Bow/Muzz either-sex or antlerless-only tags may not be used during the regular seasons except by junior bowhunters or in WMUs 1C and 3S.
- In WMUs 4J and 8C, only bows may be used to take deer during the regular and bowhunting seasons.
- Suffolk (WMU 1C) and Westchester (WMU 3S) counties have separate regular seasons restricted to bows for taking deer.

Crossbow Use

Crossbow opportunities include portions of bow seasons in addition to muzzleloader and regular seasons:

- Crossbows may be used to take deer during muzzleloader seasons and a portion of the early bow seasons (see maps on page 25) by hunters with a valid hunting or junior hunting (ages 12–15 only) license and a current muzzleloader privilege. Junior hunters (ages 14–15) may also take bear with crossbows during these seasons (see map on page 38).
- Crossbows may be used to take deer during the regular season by hunters with a valid hunting or junior hunting (ages 12–15) license and to take bear during the early bear and regular seasons by hunters with a valid hunting or junior hunting (ages 14–15 only) license.
- See page 23 for the required Crossbow Certificate of Qualification. The New York State Legislature does not allow all crossbows to be used to hunt big game in New York. See page 14 for the definition of a legal crossbow.

Barbed Broadheads

Barbed broadheads are illegal for hunting big game. A barbed broadhead is one in which the angle formed between the trailing or rear edge of any blade and the shaft is less than 90 degrees. A notch at the base of the blade extending no more than two millimeters from the shaft shall not be considered a barb. Broadheads with mechanical blades are legal if the blades DO NOT form a barb or hook when the arrow is pulled from the flesh of a deer or bear. (See graphic on page 20.)



Photo courtesy of Ella R.

Michael J. got his first deer in 2022 in Greene County.

Deer Recovery

By Bill Conners

Perched 15 feet off the ground, you saw that a buck you had been watching since late summer worked his way down a trail that brought him directly under your treestand. You did everything you could to maintain your composure, but in your excitement the perfect shot you took a few seconds later wasn't so perfect after all. The deer bounded over the hill after your broadhead passed through the animal well behind the ribcage.

When you finally started tracking the deer, what started as a good blood trail, thinned to a drop here and there, before disappearing altogether. Eventually you concluded that your best hope of recovery was to call for help from Deer Search, Inc., a dedicated group of volunteers that help hunters locate what otherwise might have been a lost animal.

In 1986 the New York State Legislature authorized the Department of Environmental Conservation to license handlers to use leashed tracking dogs to assist hunters with the recovery of big game animals. Since then, Deer Search, Inc. volunteers and their dogs have helped recover thousands of harvested deer and bear across New York.

Jared Brueggeman, a member of Deer Search, Inc. from Delaware County, was exposed to the world of tracking dogs while helping his uncle track a deer when Jared was 17 or 18 years old. Watching the dog work and being a part of the recovery effort left him with a lasting impression that stayed with him through college. After graduating with a degree in wildlife science, his experience became the catalyst for his membership in the tracking organization.

Though Brueggeman's interest had its roots in working with the dogs, he said, "I came to realize that each time a wounded or dead deer is recovered it fulfills our responsibility as conservationists and allows that animal to be used and enjoyed by the hunter and their family."

Having volunteers ready to help with recovery does not absolve hunters of the need to carefully consider any shot they are about to take. Hunters must be proficient with the bow or gun they are about to use and must ask themselves if the animal is within range, is the field of view unobstructed, and just as important, is the deer or bear positioned

correctly for a lethal shot through vital organs? You can't let your excitement get in the way of good sense and ethical judgement.

Even if the deer does take off, a well-placed shot is going to make the dog's job that much easier. "Sometimes we're just the waterboy. The dog controls the track. The hunter will tell you the deer went out 50 yards, made a hard left and I lost it in thick cover. You put the dog on the track, and it takes you in an entirely different direction" said Marc Niad, another Deer Search member from Westchester County.



Jared Brueggeman and his dog Winnie with a black bear recovered for hunter Tim Boyd in Albany County.



Tracker Marc Niad with his dog Annie and a deer recovered in Westchester County.

Crossbow Hunting Qualifications and Safety Information

A crossbow must have compound or recurve limbs with minimum width of 17 inches (outer tip of limbs excluding wheels and cams, uncocked); a minimum overall length from butt of stock to the front of the limbs of 24 inches; and be able to launch a minimum 14 inch arrow/bolt, not including the legal arrowhead. It must have a draw weight of 100 to 200 pounds.

Crossbows may be used by any person age 12 or older to hunt deer and any person age 14 or older to hunt bear, unprotected wildlife, and **most** small game species. Crossbows may not be used to take carp or any other fish.

Hunters who plan to hunt with a crossbow must have in their possession while afield either their completed Hunter Education Certificate of Qualification card dated on or after April 1, 2014 or the completed Crossbow Certificate of Qualification located below.

Crossbow safety information

- Before shooting your crossbow, read and thoroughly understand your crossbow owner's manual.
- Make sure your fingers are well away (below rail) from the path of the bow string and cables.
- Never dry-fire a crossbow (cock and fire without an arrow placed on the rail).
- Make sure the crossbow limbs are free of obstructions before shooting.
- Never carry a cocked crossbow with an arrow in it while walking.
- If hunting from a tree stand, always cock (but do not load) the crossbow on the ground before climbing into the stand.
- Once seated and secured in the tree stand, pull up your unloaded crossbow with a haul line.
- Do not place an arrow on the crossbow until you are safely secured in your stand.

- Never use a cocking device to uncock a crossbow.
- To uncock a crossbow, shoot an arrow tipped with a field point into the soft ground or a target.
- Always identify your target and the area beyond it before shooting.
- To prevent wounding game, practice often and do not take shots at game that are beyond your effective range, generally less than 30–40 yards, similar to a modern compound bow.
- To better understand how an arrow functions and the skill required for hunting with an arrow, DEC recommends all crossbow hunters take a bowhunter education course.

DEC Crossbow Hunting Qualifications:

www.dec.ny.gov/outdoor/68802.html

New York State Department of Environmental Conservation	
Crossbow Certificate of Qualification	
I certify that I have read and understand the safety recommendations, license requirements, and legal specifications for crossbow use in New York.	

Print Name	_____
Signature	_____
DEC ID# (this is your back-tag number)	Date

Fill in, cut out, and carry afield with your hunting license while hunting with a crossbow.

Big Game Boundary Descriptions/Legal Implements

Complete descriptions of all wildlife management units are available on DEC's website at www.dec.ny.gov/outdoor/8302.html.

Northern-Southern Zone Line

A line commencing at a point at the north shore of the Salmon River and its junction with Lake Ontario and extending easterly along the north shore of that river to the Village of Pulaski, thence southerly along Route 11 to its intersection with Route 49 in the Village of Central Square, thence easterly along Route 49 to its junction with Route 365 in the City of Rome, thence easterly along Route 365 to its junction with Route 28 in the Village of Trenton, thence easterly along Route 28 to its junction with Route 29 in the Village of Middleville, thence easterly along Route 29 to its junction with Route 4, thence northerly along Route 4 to its junction with Route 22, thence northerly and westerly along Route 22 to the eastern shore of South Bay on Lake Champlain in the Village of Whitehall, thence northerly along the eastern shore of South Bay to the New York-Vermont boundary.

Legal Implements for the Early Bear Season and Regular Deer & Bear Seasons

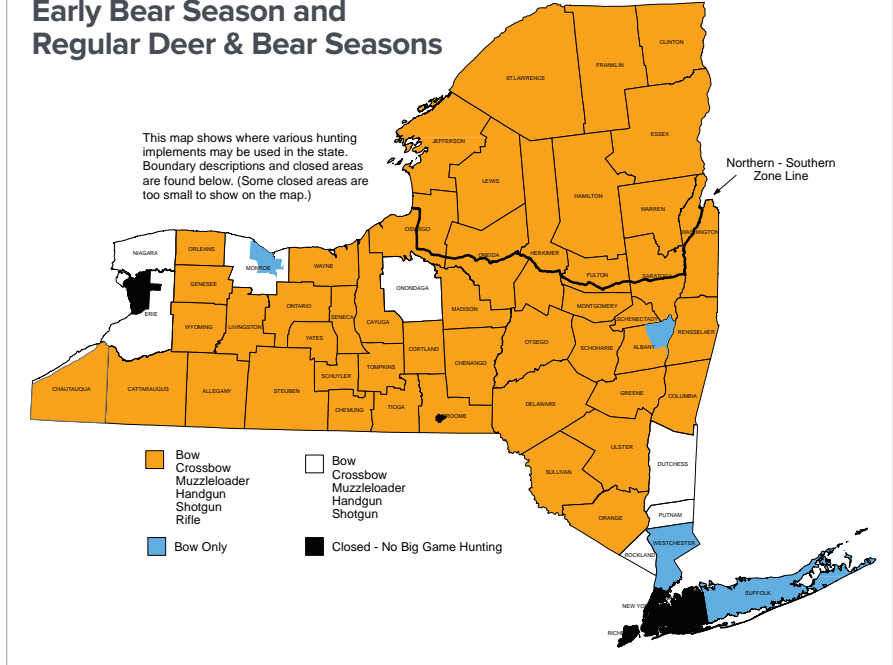

Closed Areas

The following closed areas are specific portions of the state where the taking of deer and bear is prohibited by the Environmental Conservation Law. This section does not include areas covered by town laws, local ordinances, or posting by landowners.

Broome County

City of Binghamton

Erie County

Area around Buffalo: bounded by Tonawanda Creek from East Branch Niagara River to Rt. 78 to Greiner Rd. to Rt. 268 to Rt. 5 to Ransom Rd. to Rt. 33 to Rt. 78 to Rt. 20 to Rt. 20A to Lake Erie.

Herkimer County

Area along Big Moose Lake: bounded by Judson Rd. from Herkimer-Hamilton County line to Higby Rd. to Big Moose Rd. to Martin Rd. and along it to its eastern end and then to the lake shore and back (starting westerly) along the shore to Herkimer-Hamilton County line and along it to Judson Rd.

Herkimer and Hamilton Counties

Area bounded by Rt. 28 from Old Forge to Inlet and by South Shore Rd. from Inlet to Old Forge.

Nassau County

All of Nassau County.

New York City

All of the City.

Antler Restriction Program

A mandatory antler point restriction exists in WMUs 3A, 3C, 3H, 3J, 3K, 4G, 4O, 4P, 4R, 4S, and 4W in southeastern New York (see deer hunting season maps). This program will continue as DEC encourages hunters elsewhere to practice voluntary restraint. Over time, as more and more hunters in the broader region opt to pass on young bucks voluntarily, it may be appropriate to lift the restrictions.

Antler Identification

Antler Point Restriction

- At least 1 antler with 3 or more points that are at least 1" long
- Applies to all public and private land and all seasons
- Hunters aged 12–16 are exempt and may take any buck with antlers 3" or longer

Antlerless Deer

- Adult does, doe fawns, buck fawns (button bucks), adult bucks without antlers, or with antlers less than 3" long
- May be tagged with your DMP or Bow/Muzzleloading antlerless or either-sex tags.

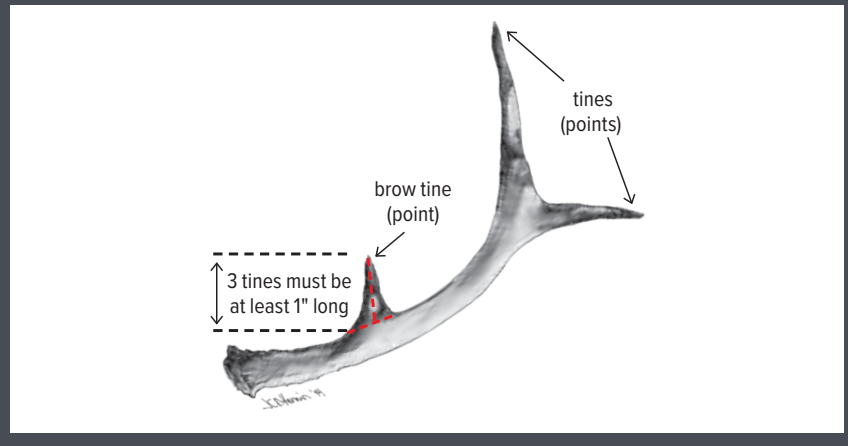

Deer Hunting

Regular and Bowhunting Deer Seasons — 2023

Hunting Hours

30 minutes before Sunrise
to 30 minutes after Sunset

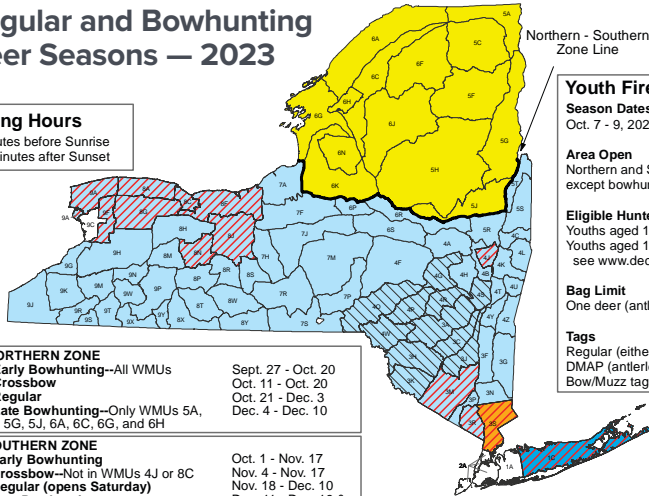

Northern - Southern
Zone Line

Youth Firearms Season

Season Dates
Oct. 7 - 9, 2023

Area Open
Northern and Southern Zone,
except bowhunting-only WMUs

Eligible Hunters
Youths aged 14-15 years (all open areas)
Youths aged 12-13 years (select counties,
see www.dec.ny.gov/outdoor/46245.html)

Bag Limit
One deer (antlered or antlerless)

Tags
Regular (either-sex), DMP and
DMAP (antlerless only);
Bow/Muzz tags are not valid

NORTHERN ZONE	
Early Bowhunting--All WMUs	Sept. 27 - Oct. 20
Crossbow	Oct. 11 - Oct. 20
Regular	Oct. 21 - Dec. 3
Late Bowhunting--Only WMUs 5A, 5G, 5J, 6A, 6C, 6G, and 6H	Dec. 4 - Dec. 10
SOUTHERN ZONE	
Early Bowhunting	Oct. 1 - Nov. 17
Crossbow--Not in WMUs 4J or 8C	Nov. 4 - Nov. 17
Regular (opens Saturday)	Nov. 18 - Dec. 10
Late Bowhunting	Dec. 11 - Dec. 19 & Dec. 26 - Jan. 1
WESTCHESTER COUNTY (3S)	
Regular--Bowhunting Only	Oct. 1 - Dec. 31
SUFFOLK COUNTY (1C)	
Regular--Bowhunting Only	Oct. 1, 2023 - Jan. 31, 2024
Special Firearms--(Permit Req.)	Jan. 7 - Jan. 31, 2024
Antler Point Restrictions	
During all seasons, antlered bucks must have at least one antler with 3 or more points that are at least 1 inch long. Young hunters (ages 12-16) are exempt.	
No Deer Hunting	

Early Antlerless Season	Sept. 9 - 17
Tags: DMP and DMAP	
Vertical Bow-Only: 1C, 3S, 4J, 8C	
Firearms, Bow, & Crossbow: 3M, 3R, 8A, 8F, 8G, 8J, 8N, 9A, and 9F	

Crossbows

May be used to hunt deer during the Northern and Southern Zone Regular Seasons.
May not be used to hunt deer:
- during the Youth Firearms Season; or
- anytime in WMUs 1C (Suffolk County), 3S (Westchester County), 4J or 8C.

Legislation adopted in 2021 allows 12- and 13-year-olds to hunt deer with a firearm or crossbow under supervision of an adult hunter in upstate counties that choose to participate. For a list of counties that have opted in go to www.dec.ny.gov/outdoor/46245.html.

Muzzleloading Deer Seasons — 2023

Hunting Hours

30 minutes before Sunrise
to 30 minutes after Sunset

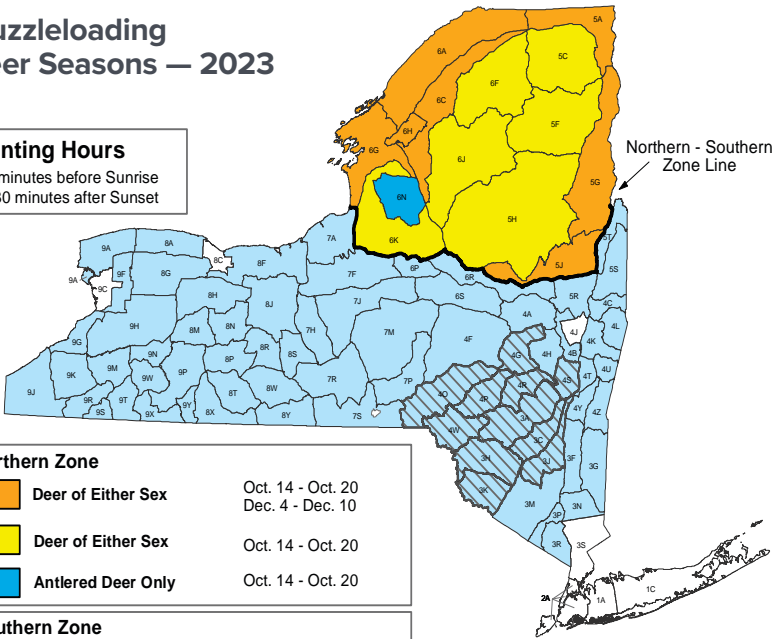

Northern - Southern
Zone Line

Northern Zone	
Deer of Either Sex	Oct. 14 - Oct. 20 Dec. 4 - Dec. 10
Deer of Either Sex	Oct. 14 - Oct. 20
Antlered Deer Only	Oct. 14 - Oct. 20
Southern Zone	
Deer of Either Sex	Dec. 11 - Dec. 19 Dec. 26 - Jan. 1
Antler Point Restrictions	
During all seasons, antlered bucks must have at least one antler with 3 or more points that are at least 1 inch long. Young hunters (ages 12-16) are exempt.	
No Muzzleloading Season	





Crossbows

May be used to hunt deer during the Northern and Southern Zone Muzzleloader Seasons.
May not be used to hunt deer anytime in WMUs 1C (Suffolk County), 3S (Westchester County), 4J or 8C.

Deer Hunting

Deer Tag Descriptions

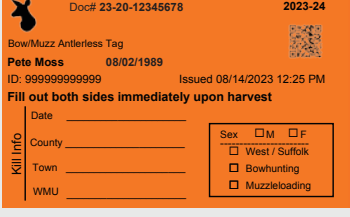
For all season dates, see page 25. See page 11 for privilege information.

Tag Name	Tag Can Be Used In	Tag Is Valid For
<p>Regular Season Deer Tag Only you may hunt with this tag. No transferring tag to another hunter.</p>	<p>Regular Season</p> <ul style="list-style-type: none"> Northern Zone Southern Zone <p>Westchester County</p> <ul style="list-style-type: none"> Regular (bowhunting only) <p>Suffolk County</p> <ul style="list-style-type: none"> Regular (bowhunting only) Special Firearms (special permit, see page 18) <p>Late Season Bowhunting (privilege required)</p> <ul style="list-style-type: none"> Northern Zone Southern Zone <p>Late Season Muzzleloading (privilege required)</p> <ul style="list-style-type: none"> Northern Zone (check open areas and dates on map on page 25) Southern Zone <p>Youth Deer Season</p>	<p>Antlered Deer Only</p> <p>Except: May be used for Antlered or Antlerless Deer as follows:</p> <ul style="list-style-type: none"> In Westchester County (WMU 3S) In Suffolk County (WMU 1C) In areas restricted to bowhunting only (WMUs 4J and 8C) In late seasons (with bowhunting or muzzleloading privilege) By Junior Hunters during the Youth Deer Hunt IF you have a non-ambulatory permit. 
<p>Bow/Mz Season Either Sex Tag Only you may hunt with this tag. No transferring tag to another hunter.</p>	<p>Bowhunting Season (privilege required)</p> <ul style="list-style-type: none"> Northern Zone Southern Zone <p>Muzzleloading Season (privilege required)</p> <ul style="list-style-type: none"> Northern Zone (check open areas and dates on map on page 25) Southern Zone <p>Westchester County</p> <ul style="list-style-type: none"> Regular (bowhunting only) <p>Suffolk County</p> <ul style="list-style-type: none"> Regular (bowhunting only) Special Firearms (special permit; see page 18) <p>Not valid during the Northern or Southern Zone Regular Seasons or Youth Hunt except as specified in right-hand column.</p>	<p>Antlered or Antlerless Deer</p> <p>Bowhunting or Muzzleloading seasons only (including the regular season in Westchester County and the regular and special firearms seasons in Suffolk County), corresponding to the privileges purchased.</p> <p>Junior Bowhunters will receive this tag, which will be valid in the special bowhunting seasons and during the regular season, with bowhunting equipment only.</p> <p>Except:</p> <ul style="list-style-type: none"> May be used for antlered deer only during muzzleloading seasons in certain Northern Zone WMUs (see map page 25). 
<p>Bow/Mz Season Antlerless Tag Only you may hunt with this tag. No transferring tag to another hunter.</p>	<p>Bowhunting Season (privilege required)</p> <ul style="list-style-type: none"> Northern Zone Southern Zone <p>Muzzleloading Season (privilege required)</p> <ul style="list-style-type: none"> Northern Zone (check open areas and dates on map, page 25) Southern Zone <p>Westchester County</p> <ul style="list-style-type: none"> Regular (bowhunting only) <p>Suffolk County</p> <ul style="list-style-type: none"> Regular (bowhunting only) Special Firearms (special permit; see page 18) <p>Not valid during the Northern or Southern Zone Regular Seasons or Youth Hunt except as specified in right-hand column.</p>	<p>Antlerless Deer Only</p> <p>Bowhunting or Muzzleloading seasons only (including the regular season in Westchester County and the regular and special firearms seasons in Suffolk County), corresponding to the privileges purchased.</p> <p>Except:</p> <ul style="list-style-type: none"> May not be used during muzzleloading seasons in certain Northern Zone WMUs that are Antlered Deer Only areas (see map page 25). May be used by junior Bowhunters during the Bowhunting and Regular Seasons. 
<p>Deer Management Permit Deer Tag</p>	<p>Any Open Deer Season</p>	<p>Antlerless Deer Only</p> <p>Valid only for the WMU specified and printed on the DMP Deer Tag (Deer Management Permit). See page 29.</p> <p>This is the only tag that can be transferred to another hunter (see page 29 for How to Transfer a DMP Deer Carcass Tag).</p> 

For information on which tags may be used when hunting with a crossbow, see page 21.

Report Your Moose Sightings

Moose are protected in New York and cannot be hunted. DEC and its research partners are working to understand the status of the moose population. You can help us by reporting moose sightings at www.dec.ny.gov/animals/6964.html.



Photo by Steve Spudie



Dave K. with his favorite hunting companion, Merica. Merica is 12 years old and has lived in six different states with Dave. "She's getting a bit up in years, but she still goes nuts when she sees a shotgun."

Deer Management Permits (DMPs)

Hunters possessing a DMP may take one antlerless deer per permit in addition to any deer that may be taken with a regular hunting license or bowhunting and muzzleloading privileges.

- DMPs may not be used for legally antlered deer (at least one antler 3" or longer).
- DMPs may be used in any open season only in the WMU they are issued for.
- Hunters may transfer or receive up to 2 DMPs from other hunters (see page 29).

Applying for a DMP

- **DMP Application Deadline: Close of business on October 1, 2023**
- You may apply for DMPs at all license-issuing outlets, by phone, or online beginning on August 1, 2023.
- DMPs are available to all hunters age 14 years or older who purchase or possess a regular hunting license (12 years old for Junior Bowhunting license holders).
- There is a \$10 nonrefundable application fee for all applicants. The fee is waived for holders of Lifetime Licenses purchased prior to 10/1/2009, and Junior Hunters and Junior Bowhunters.
- **Know your Wildlife Management Unit (WMU) before you apply.** If you are unsure of your unit, see the WMU maps on pages 70–77 of this guide or visit www.dec.ny.gov/outdoor/8302.html for written boundary descriptions. You may also call the DMP Hotline for additional information at 1-866-472-4332.
- You may apply for up to two DMPs. Both must be applied for at the same time. Application can be for DMPs in the same WMU or different WMUs.

- **Disabled veterans** with a service-connected disability rated at 40% or greater (who are residents of New York) will receive preference on DMPs. Annually, you must bring a letter from the Department of Veterans Affairs, dated in the current year, with your case number and your disability percentage. If you are claiming permanent disabled status, the letter must clearly state that the 40% or more service-related disability is permanent.
- **Landowners: It is illegal for more than one person per 50-plus-acre tax map ID to apply as a landowner.** If you own 50 or more contiguous acres of land within the WMU you will be hunting in, you will receive preference on DMP selection. Annually, you must bring your tax map identification number and SWIS code (found on your tax bill) with you when you apply. Be sure to tell the license-issuing agent prior to applying that you are a landowner. Lessees do not qualify as landowners.
- **Corporate ownership: It is illegal for more than one person to apply as a corporate landowner no matter how many 50-acre parcels are owned.** The corporation must submit an original letter or certified copy of a resolution, dated in the current year, designating one individual and must include the tax map ID and SWIS code information.
- **Group ownership: It is illegal for more than one person per 50-plus-acre tax map ID to apply as a landowner,** regardless of how many co-owners. Additional 50-plus-acre parcels in the same WMU require separate tax IDs.
- **Preference points:**
 - » Preference points increase your chances of selection, but do not guarantee DMP selection.

Chances of DMP Selection

Your chances of selection for first and second DMPs by Wildlife Management Unit are available online at <http://www.dec.ny.gov/outdoor/30409.html>, posted at all License Issuing Outlets or by calling our Deer Management Permit hotline at 1-866-472-4332. Chances of DMP selection remain the same throughout the entire DMP application period.

- » Preference points are won and lost on first permit selection only.
- » If you receive a DMP in your first choice WMU, all available preference points will be used.
- » If you do not receive a DMP in your first choice WMU, you will receive a preference point for the following year.
- » Any preference points contained in your file are automatically applied to your first-choice WMU selection, even if preference points are not required for that unit.
- » If you do not receive your first choice, the points are applied to your second choice, but will remain in your file for the following year, regardless of your second-choice selection results.
- » Qualifying landowners and disabled veterans will receive their first choice DMP in all open WMUs.
- » Preference Points are not WMU specific. That is, if you earned a preference point by being denied in one WMU, you can use that preference point in a subsequent year when applying for a DMP in a different WMU.

Hunter Education: Next Step Courses

The DEC's Hunter Education Program (HEP) is now offering Next Step courses for people who have already completed a hunter education, bowhunter education, or trapper education certification course and want more education and hands-on experience.

- Taught by HEP staff and certified HEP instructors.
- 4-Hour courses focus on safety, techniques and hands-on experience in:
 - » rifle, shotgun, crossbow, archery, fur handling, land trapping, and water trapping.

All Next Step Courses are FREE

- Registration with your certificate number is required.
- Minimum age is 12 years old.
- No certification is offered in these courses.

For more information and to register, visit www.dec.ny.gov/outdoor/92267.html or scan the QR code.



BOW instructor Jeff Peil with student



DMP selection order

During the instant issuance, an applicant's chances of selection are determined by an applicant's category. The categories, in priority order, are as follows:

1. Landowners (50 or more acres of land within a WMU) and Disabled Veterans (40% or more service-related disability). All applicants in this category will receive their first-choice DMP.
2. NYS Residents and Non-residents with 3 Preference Points
3. NYS Residents with 1–2 Preference Points
4. NYS Residents without Preference Points
5. Non-residents with 1–2 Preference Points
6. Non-residents without Preference Points

Additional DMP opportunities

Bonus DMPs: If you fill a DMP in bowhunting-only WMUs 1C, 3S, 4J and 8C, you can apply for a bonus permit for another antlerless deer. Bonus permits may only be obtained from regional wildlife staff at predetermined locations. For complete information, visit our website or call a DEC Regional Wildlife Office as follows:

- WMU 1C..... 1-631-444-0310
- WMU 3S..... 1-845-256-3098
- WMU 4J..... 1-518-357-2154
- WMU 8C..... 1-585-226-5380

Leftover DMPs: If there are still permits remaining after the initial DMP instant-issuance period closes on October 1 and the back-end correction selections have occurred, the remaining DMPs may be available on a first-come-first-served basis, beginning on or around November 1. These DMPs are only available in person at license-issuing agents. Leftover DMPs will not be available by phone or online. The Wildlife Management Units with permits available will be announced by news release and on our website (www.dec.ny.gov). If you already applied for a DMP during the initial application period, there is no additional application fee. If you are applying for the first time this hunting season, you will have to pay a \$10 application fee. Fee is waived for Resident and Non-resident Junior Hunters and Junior Bowhunters, and for Lifetime License holders who purchased prior to October 1, 2009. You will be allowed up to two DMPs during the first-come-first-served application period in addition to any you may have received during the initial application period.

Deer Management Assistance Program

The Deer Management Assistance Program (DMAP) enables wildlife biologists to help landowners and resource managers implement site-specific deer management on their lands. In doing so, DEC issues a special permit for use only during the open deer hunting seasons and a determined number of antlerless deer tags to landowners or resource managers whose property is in need of site-specific deer management efforts. Hunters are expected to report their harvest. For more information on the program, refer to www.dec.ny.gov/animals/33973.html.

How to Transfer a DMP Deer Carcass Tag

Hunter Jane Doe wants to transfer her DMP tag to hunter Pete Moss.

Step 1. Jane Doe signs the bottom of her DMP tag.

Step 2. Jane Doe gives the DMP tag to Pete Moss.

Step 3. Pete Moss records the DOC# of the DMP tag on his reporting panel, completing the transfer.

Step 4. If Pete Moss takes an antlerless deer with the transferred DMP, he is required to report the deer by calling the automated reporting system (1-866-426-3778) or by reporting online at www.dec.ny.gov/outdoor/8316.html using the transferred DMP DOC# and his own date of birth.

- Hunters are allowed to receive only two transferred DMPs per year.
- DMPs can be transferred from the receiving hunter back to the original hunter or to another. The other hunter must record the DOC# on his/her reporting panel, as in Step 3 above, to complete the transfer.

Remember: Hunting licenses are not transferable. Only DMP carcass tags can be used by another hunter. A hunter must be in physical possession of a DMP when taking antlerless deer pursuant to a DMP. It cannot be shared by a group afield.

Note: To report a deer taken on a transferred DMP, the hunter who took the deer must call the automated reporting system (1-866-426-3778) or report online at www.dec.ny.gov/outdoor/8316.html using the transferred DMP carcass tag DOC# and their own date of birth, along with other required information (see page 13).

Doc# 23-04-12345678 2023-24

DMP Deer Carcass Tag

Jane Doe 08/02/1989

ID: 314114431020 Issued 08/24/2023 10:52 AM

Fill out both sides immediately upon harvest

Kill Info: Date _____ Sex M F
 County _____ Reg Season
 Town _____ Bowhunting
 Muzzleloading
 Youth

WMU 4H Signature Jane Doe
 I authorize the transfer of my DMP

DMP carcass tag of hunter Jane Doe

ID: 999999999999 Valid 09/01/2023-08/31/2024

DMP #'s received from other hunters (limit 2 tags/yr):

23-04-12345678 _____
 _____ _____

Reporting panel of hunter Pete Moss

Put Down Some Roots!

With Trees and Shrubs from DEC's Nursery

Dozens of varieties of NY-grown seedlings are available for affordable prices during our annual sale, open January through mid-May.

**Colonel William F. Fox Memorial
Saratoga Tree Nursery
(518) 581-1439
www.dec.ny.gov/animals/9395.html**

Feral Swine Cause Damage!



Manage the Damage
Stop Feral Swine

Feral Swine damage agriculture, natural resources, property, people, and cultural sites.



For more information:

Call 1-866-4-USDA-WS or
Your state wildlife agency



DMAP on State Lands

DEC has enrolled several state lands in DMAP. Tag availability is limited and hunters must apply to participate. See www.dec.ny.gov/outdoor/121387.html for information. Properties include:

- Bully Hill State Forest, WMU 9P
- Doodletown Wildlife Management Area, WMU 4Z

Eurasian Boar

Eurasian boars are a destructive invasive species that damage habitat and crops, and threaten native wildlife and domestic livestock. DEC and USDA have worked hard to eradicate these animals from the state's landscape. We are now working to prevent their reintroduction into New York.

- It is illegal to possess, sell, distribute, trade, or transport Eurasian boars or their hybrids.
- It is illegal to import, breed, or release Eurasian boars or their hybrids.
- It is illegal to hunt, trap, or take free-ranging Eurasian boar or their hybrids.

Although DEC's eradication efforts have been very successful to date, we must remain vigilant. Anyone who sees a Eurasian boar should report it to DEC as soon as possible by emailing wildlife@dec.ny.gov or calling 518-402-8883.

Become a Hunter Education Program Instructor

Safety. Responsibility. Ethics.



"I volunteer my time to the Hunter Education Program because I get more out of it than I give. Those few hours give me a greater appreciation for all things conservation. The smiles of a child that can now go afield with purpose, men and women who will get to put fresh game on their tables, and a new group of people with a greater understanding of the wildlife and nature around them."

Ann Wilcox-Swanson, Instructor



Qualifications

- At least 18 years of age
- Good communication skills
- Hunting experience preferred
- Good moral character

APPLY TODAY! 1-888-HUNTED2 <https://www.dec.ny.gov/outdoor/7860.html>

Non-Lead Ammunition Rebate Program:

Hunters For Eagle Conservation in New York



Lead rifle bullets and shotgun slugs are relatively soft and heavy, but can fragment into hundreds of small pieces upon impact. Gut piles from field-dressed deer can be contaminated with these small lead fragments, making them available to Bald and Golden Eagles and other scavenging wildlife that readily consume these gut piles. In recent years, ingestion of lead fragments has resulted in the impairment and death of Bald and Golden Eagles in New York.

While Bald Eagle abundance has been increasing in New York, the population growth is reduced due to lead poisoning. Golden Eagles commonly stop in New York during migration and feed upon gut piles and dead deer. Unlike Bald Eagles, the eastern population of Golden Eagles is not increasing. Therefore, lead poisoning from consuming contaminated gut piles makes the Golden Eagle more susceptible to potential population declines.

Non-lead Ammunition Rebate Program for Deer Hunters

DEC has partnered with the New York Cooperative Fish and Wildlife Research Unit at Cornell University, United States Geological Survey, and Conservation Science Global to implement a multiyear study to determine the reduction in eagle deaths resulting from use of non-lead ammunition for deer hunting. Researchers are offering a rebate of up to \$60 for purchase of certified non-lead ammunition and for participation in pre- and post-hunt surveys. Certified non-lead ammunition has <1% lead content and a list of manufacturers and non-lead bullet calibers can be found at huntersforeagleconservation.org/new-york/.

2023-2024 Eligible WMUs

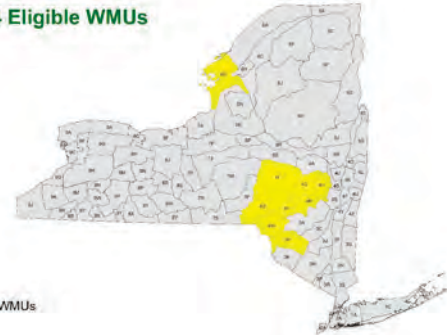

To Learn More and Sign-up!

This is a voluntary program limited to wildlife management units (WMU: 3H, 4F, 4G, 4H, 4O, 4P, 4R, 4W, and 6G). Only hunters who possess a 2023–24 DMP for a WMU in the project area are eligible, and they must participate in an associated pre- and post-hunting season surveys. To learn more and sign-up, go to huntersforeagleconservation.org/new-york/. For more information on DEC efforts to minimize risks from lead ammunition please visit www.dec.ny.gov/outdoor/48420.html.

Questions? wildlife@dec.ny.gov (subject: non-lead ammo study).

4 Rules of Firearm Safety

1. Keep the muzzle pointed in a safe direction at all times!

2. Treat every firearm as though it is loaded!



3. Be sure of your target and what is in front of and beyond it!

4. Keep your finger off the trigger and outside the trigger guard until ready to shoot!



Department of Environmental Conservation

Hunter Education Program

Doe or Fawn?

During the fall, it can often be difficult to distinguish adult does and fawn deer, particularly if seen alone. In recent years, about 20% of the total antlerless deer harvest has been fawns (5–7 months old), with nearly even proportions of doe fawns and buck fawns. Though fawns provide excellent table fare, some hunters prefer to target adult deer. Taking female deer contributes to management objectives, and passing buck fawns may allow some of them to be available later as antlered bucks. By learning the differences between antlerless deer, hunters can make more informed harvest choices.

Hunting Tips

- Button bucks often travel alone, but adult does rarely do. Wait until several antlerless deer are present before making a harvest decision.
- It is easier to identify sex and age when animals are standing still or moving slowly.
- Harvest antlerless deer early in the season when differences between fawns and adult does are most noticeable.

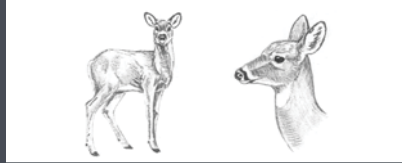

Fawn

- Body about as long as tall (square)
- Short neck and compact nose/head
- Eyes look large for head
- Doe fawns have a more rounded head shape between their ears
- Buck fawns' heads appear flattened and may have visible antler nubs or "buttons"

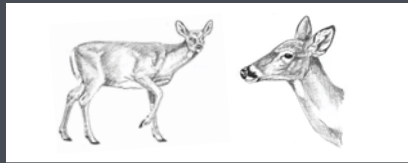

Adult Doe

- Body longer than tall (rectangle)
- Long neck and elongated nose

Tree Stand Safety — Hunt Safe, Hunt Smart

- Read the manufacturer's instructions. Replace worn/missing parts.
- Use a full-body harness with a foot strap to relieve harness leg pressure.
- Use a "lifeline" or safety rope that is secured at base of the tree or stand and to the tree just above your head when sitting in the stand. Stay connected to a lifeline from the time you leave the ground to the time you get back down.
- Attach the tether from your full-body harness to the lifeline using a carabiner and prusik knot, which easily slides up and down the lifeline.
- Once secured in your stand, use a haul line to raise/lower unloaded implements and quiver. Do not tie the haul line around the trigger or trigger guard. Haul unloaded guns, bows, and cocked (but unloaded) crossbows pointed down.
- Carry emergency equipment (knife, phone, flashlight, whistle) in your pockets at all times, not in your pack.
- Tell someone where you will be hunting and when you will return.



Photo by Gary K.

In addition to the Tree Stand Safety steps above, it's important to know the health and species of the tree you choose to support your stand. In New York State there are a handful of tree species that are currently being impacted by non-native pests and pathogens that should be avoided. The most common trees that are either dead or are in the process of dying are: Ash species (*Fraxinus spp.*), Butternut (*Juglans cineria*), American beech (*Fagus grandifolia*), Eastern hemlock (*Tsuga canadensis*), and American elm (*Ulmus americana*).

HUNTERS: Want Older Bucks in New York?

It's Your Choice

You can increase the availability of older bucks by choosing to pass up shots at young bucks.

- Older bucks create more rubs and scrapes, vocalize more, and yield more meat – all things that create unforgettable hunting experiences.

You can boost deer condition and body and antler size by balancing the deer population with the habitat:

- Take a doe if permits are available in your area.
- Create young forest to enhance natural forage and cover for deer.



Let go

YOUNG BUCKS and watch them

GROW

YOUR CHOICE MAKES A DIFFERENCE!

NEW YORK STATE

Department of Environmental Conservation

Big Game Season Dates

Future Big Game Season Dates			
Northern Zone			
Bear	Adirondacks (WMUs 5A, 5C, 5F, 5G, 5H, 5J, 6C, 6F, 6H, and 6J)	Regular	First Saturday after the second Monday in September through the Sunday immediately following the first Saturday in December.
	Western Periphery (WMUs 6A, 6G, 6K, 6N)	Early Bowhunting	First Saturday after the second Monday in September through the Friday immediately preceding the regular season (crossbows can be used during the last 10 days of this season).
		Early Muzzleloading	7 consecutive days beginning on the first Saturday after Columbus Day.
Deer		Regular	Second Saturday after Columbus Day through the Sunday immediately following the first Saturday in December.
		Early Bowhunting	September 27 through the Friday immediately preceding the regular season (crossbows can be used during the last 10 days of this season).
		Early Muzzleloading	7 consecutive days beginning on the first Saturday after Columbus Day.
		Regular	44 consecutive days beginning on the second Saturday after Columbus Day.
		Late Bow and Muzzleloading (some WMUs)	7 consecutive days immediately following the regular season.
Southern Zone			
Bear		Early Antlerless (some WMUs)	16 consecutive days beginning the first Saturday after Labor Day.
		Early Bowhunting	October 1 through the Friday immediately preceding the regular season (crossbows can be used during the last 14 days of this season).
		Regular	23 consecutive days beginning the third Saturday in November.
		Late Bow and Muzzleloading	9 consecutive days immediately following the regular season.
Deer		Early Firearms (some WMUs)	9 consecutive days beginning the second Saturday of September.
		Early Bowhunting	October 1 through the Friday immediately preceding the regular season (crossbows can be used during the last 14 days of this season).
		Regular	23 consecutive days beginning the third Saturday in November.
		Late Bow and Muzzleloading	9 consecutive days immediately following the regular season and December 26 through January 1.
Northern & Southern Zone			
Deer & Bear	Youth (ages 12-15)		3 consecutive days beginning on the Saturday of Columbus Day Weekend.
Westchester County			
Deer & Bear	Regular (bowhunting only)		October 1 through December 31.
Suffolk County			
Deer	Regular (bowhunting only)		October 1 through December 31.
	Special Firearms Season		First Sunday in January through Jan 31.

Special Seasons Designated for Young Hunters



Jack R. after a successful harvest



Jason B. with a 9 point taken with a bow



Sam D. had a victorious hunt with his father

Introducing a new generation to the outdoors – Take a youth hunter afield this fall

Once again, DEC is providing a special youth deer season over the three-day Columbus Day weekend. Junior hunters (ages 12–15) are eligible to take one antlered or one antlerless deer with a firearm and 14- and 15-year-old junior hunters may also take a bear with a firearm during this season. Rules of the Junior Hunter Mentoring Program (page 37) also apply.

DEC also offers special opportunities for junior hunters (ages 12–15) for waterfowl, wild turkey, and pheasants.

For all youth hunts, junior hunters must be accompanied by an adult hunter. Both the junior and adult hunters are required to have a hunting license for the youth deer season, a hunting license and a turkey permit for the turkey hunt, and a hunting license and current HIP registration for the waterfowl hunt. During the youth waterfowl hunt, the supervising adult must also have a federal duck stamp. During the youth pheasant, turkey, and big game hunts, adult hunters are not allowed to possess a firearm, crossbow, or bow, or to harvest an animal while accompanying a junior hunter. During the youth waterfowl hunt the adult hunter supervising the junior hunter may not carry a firearm, longbow, or crossbow afield, but the prohibition does not apply to other hunters in the party that are not mentoring the junior waterfowl hunter.

Crossbows may be used by 12- and 13-year-old hunters only to take deer. Hunters ages 14 and 15 may use a crossbow to take deer, bear, and other game for which crossbows may be used.

Note: Junior hunters (ages 12–15) must be accompanied by a licensed adult hunter whenever they are afield in pursuit of game, not just during designated special youth seasons.

Youth Hunts	
Youth Pheasant Hunt	
Northern and Eastern New York	September 23–24, 2023
Western New York	October 14–15, 2023
Long Island	October 28–29, 2023
Youth Waterfowl Hunt	
Waterfowl Hunting Zone	Dates
Northeastern	September 23–24, 2023
Southeastern	September 23–24, 2023
Lake Champlain	September 23–24, 2023
Western	September 30 and October 1, 2023
Long Island	November 4–5, 2023
Youth Wild Turkey Hunt	
Upstate NY (north of Bronx-Westchester Co. boundary) and Suffolk County	April 20–21, 2024
Youth Firearms Deer and Bear Hunt	
Upstate NY (north of Bronx-Westchester Co. boundary; excluding bowhunting-only WMUs)	Columbus Day Weekend; October 7–9, 2023

Take them outside the classroom. Way outside.

EXPLORE BOWHUNTING

The NYSDEC has partnered with the Archery Trade Association to bring you a next step archery program with curriculum that includes over 20 introductory lessons to bowhunting for youth ages 11-17.

Contact the NY Explore Bowhunting coordinator for local instructor training opportunities.
P: 518-402-8967 E: hunter@dec.ny.gov

New York is on Target!

The **National Archery in the Schools Program**:

- Is an archery program for grades 4-12
- Is taught during school in the curriculum
- Includes instructor training
- Uses standardized equipment
- Has 40,000 students participate annually

NASP
NATIONAL ARCHERY IN THE SCHOOLS PROGRAM

For more information, please contact NY NASP at 518-402-8967, or hunter@dec.ny.gov

Junior Big Game Hunting

NEW OPPORTUNITY: 12- and 13-year-old can hunt deer with a gun or crossbow in counties that opt in

A new law adopted in 2021 reduced the age for hunting deer with firearms and crossbows:

- Counties must pass a local law allowing the activity. See DEC website (www.dec.ny.gov/outdoor/46245.html) for a list of counties that have opted in.
- 12- and 13-year-olds can hunt deer with a rifle, shotgun, or muzzleloader during the youth deer hunt or regular season, and hunt deer with a muzzleloader during the early or late muzzleloading season.
- 12- and 13-year-olds can hunt deer with a crossbow during the crossbow portion of the early bow season, the regular season, and late muzzleloading season.
- The new law does not authorize bear hunting.

12- and 13-year-old hunters must meet the same requirements as 14- and 15-year-olds hunting deer with a firearm.

12- and 13-year-old junior bowhunters can hunt deer and bear with a bow if they meet the following requirements:

- They have completed a course in both Hunter Education and Bowhunter Education.
- They have purchased a Junior Bowhunting License.
- They are accompanied by a parent, legal guardian, or a youth mentor who is 21 years or older and designated in writing by the

junior hunter's parent or legal guardian (use the form below).

- The accompanying adult needs to have at least 3 years of experience in hunting deer or bear by longbow and have a license to hunt big game in the same seasons.
- The parent, guardian, or youth mentor must maintain physical control over the minor at all times while hunting.

14- and 15-year-old junior hunting license holders can hunt deer and bear with a gun if they meet the following requirements:

- They have completed a course in Hunter Education.
- They have purchased a Junior Hunting License.
- They are accompanied by a parent, legal guardian, or a youth mentor who is 21 years or older designated in writing (use the form below).
- The accompanying adult needs to have at least 3 years of hunting experience and have a license to hunt big game in the same seasons.
- The parent, guardian, or youth mentor must maintain physical control over the minor at all times while hunting.
- The Junior Hunter must stay on the ground and cannot use an elevated (tree) stand.
- Both junior hunter and accompanying adult must wear fluorescent orange or pink: a shirt or jacket with 250 sq inches of solid/patterned fluorescent orange or pink (the pattern must

be no less than 50% fluorescent orange or pink) or a hat with no less than 50% of the exterior consisting of solid fluorescent orange or pink and visible from all directions.

14- and 15-year-old junior bowhunters and first-time 16- and 17-year-old big game hunters must:

- Be accompanied by a parent, legal guardian, or person 18 years or older designated in writing (use form below).
- The accompanying adult needs to have at least 1 year of hunting experience and have a license to hunt big game in the same seasons.

Junior Trapping

Trappers under 12 years of age:

- May accompany and assist a licensed trapper in all aspects of trapping without possessing a trapping license themselves.
- The licensed trapper must have at least 3 years of trapping experience and may be a parent, legal guardian, or someone 18 years or older designated in writing (use the form below).

Junior Trappers 12 years or older:

- Must complete NY's Trapper Education Program whether they will be trapping alone or with an adult licensed trapper.

Share Your Hunting and Trapping Photos With Us!

Help us celebrate the successes of young and first-time hunters and trappers by submitting photographs to DEC's Hunting and Trapping Photo Gallery:

www.dec.ny.gov/outdoor/54055.html

New York State Department of Environmental Conservation

Mentored Youth Hunter and Trapper Permission Form

Use this form to designate a licensed adult hunter or trapper to accompany young hunters or trappers.

I, _____ am the parent/legal guardian
(Print name of parent or legal guardian above.) (Please circle one.)

of _____, and I hereby give permission for him or her
(Print name of young hunter/trapper above.)

to be accompanied by _____ whom I acknowledge meets
(Print name of adult hunter/trapper above.)

the legal age, experience, and licensing requirements to function as a mentor during hunting and trapping seasons.

Signature: _____
(Parent or legal guardian sign above.)

Date _____
(Print today's date above.)

Telephone Number _____
(Print phone number above.)

Attention Young Hunter or Trapper: carry this form with you while afield.

Bear Hunting



Evan F. after a successful hunt

Black Bear Seasons — 2023

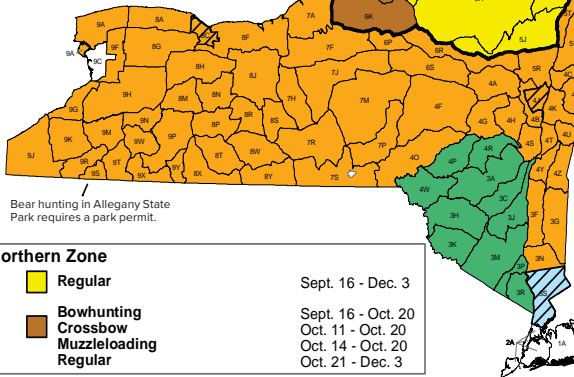

Bear hunting in Allegany State Park requires a park permit.

Hunting Hours

30 minutes before Sunrise to 30 minutes after Sunset

Youth Firearms Season

Season Dates
Oct. 7 - 9, 2023

Area Open
Northern and Southern Zone, except bowhunting only WMUs

Eligible Hunters
Youth 14-15 years of age

Northern Zone

Regular	Sept. 16 - Dec. 3
Bowhunting Crossbow Muzzleloading Regular	Sept. 16 - Oct. 20 Oct. 11 - Oct. 20 Oct. 14 - Oct. 20 Oct. 21 - Dec. 3

Southern Zone

Early Firearms	Sept. 9 - Sept. 24
Early Bowhunting Crossbow--Not in WMUs 4J or 8C Regular Late Bowhunting Late Muzzleloading	Oct. 1 - Nov. 17 Nov. 4 - Nov. 17 Nov. 18 - Dec. 10 Dec. 11 - Dec. 19 Dec. 11 - Dec. 19
Westchester County (3S) Regular--Bowhunting Only	Oct. 1 - Dec. 31

Bowhunting Only WMUs
No Bear Hunting

Crossbows

- May be used to hunt bear during the early bear seasons, muzzleloader seasons, and the regular firearms seasons.
- May not be used to hunt bear anytime in WMUs 3S (Westchester County), 4J or 8C.

Bear Hunting

- Resident and non-resident hunters can receive a bear carcass tag with their hunting license and may take one bear per year.
- In the Southern Zone, hunters may not shoot a cub or a bear that should be known to be a cub, shoot any bear from a group of bears, or shoot or take a bear from its den.
- Hunters may use and carry up to 1.5 fluid ounces of a liquid scent or lure, though such scent or lure may not be placed in a manner that it may be consumed as bait.
- Hunting bear with the aid of bait or dogs is prohibited.



iSeeMammals

Help researchers study NY bears!



Collect data about presence and absence from your observations + hikes + trail cams
isemammals.org

*See map on page 24 for information on legal implements during the early and regular bear seasons.

New York State Bear Management Cooperator Program

The Bureau of Wildlife is requesting the assistance of successful black bear hunters in New York State.

Hunters who harvest a bear in New York are required to report their harvest through the DECALS telephone system at 1-866-426-3778 (1-866-GAMERPT), via the mobile app, or use the new online Harvest Reporting System at www.dec.ny.gov. Successful bear hunters are also asked to submit a premolar tooth or part of the lower jaw of the bear for DEC to determine the bear's age and to record the dressed weight of the bear (see www.dec.ny.gov/outdoor/45598.html for more information). Successful bear hunters will be sent a tooth collection packet with premolar removal and submission instructions. Hunters may be contacted by a DEC wildlife biologist to examine your bear and extract a premolar tooth for aging.

Report your bear and return a bear tooth to receive a commemorative 2023 NYS Black Bear Cooperator Patch. Samples will be aged in the summer of 2024. Cooperating hunters will receive patches and letters indicating the age of their bear in early fall 2024.



Attention Bear Hunters and Taxidermists

Bear gallbladders and bile shall not be possessed or sold unless a valid bear tag (original or copy of bear carcass tag) is attached. New York State law requires taxidermists to keep records of all bear gallbladders and bile received or sold.

Become BearWise

In 2022, DEC became a cooperating partner of BearWise®, a multi-state campaign focused on educating people on how to live responsibly with black bears. The campaign provides sound information and smart solutions that help homeowners, businesses and communities coexist with black bears. Visit <https://bearwise.org/> to learn the BearWise basics, bear safety tips, and to download educational resources. Become NYS BearWise to help keep New York State's black bears healthy and safe.





Remember to Report Your Game Harvest

HuntFishNY Mobile App * 1-866-426-3778 * www.dec.ny.gov

Most regulations are in effect September 1, 2023 through August 31, 2024

REGULAR & BOWHUNTING DEER SEASONS 2023

Hunting Hours:
30 minutes before sunrise to 30 minutes after sunset

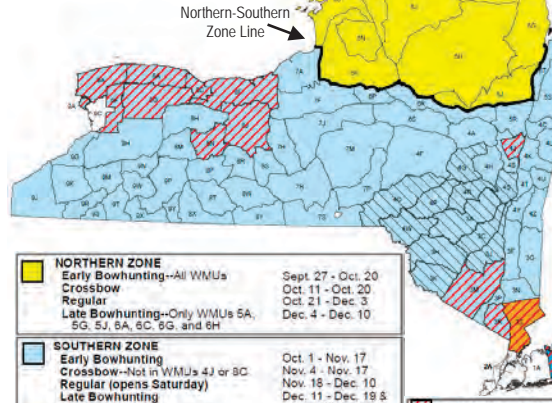

Youth Firearms Season
Season Dates
Oct. 7 - 9, 2023

Area Open
Northern and Southern Zone, except bowhunting-only WMUs

Eligible Hunters
Youth 14-15 years (all open areas)
Youth aged 12-13 years (select counties, see www.dec.ny.gov/outdoor/46245.html)

Bag Limit
One deer (antlered or antlerless)

Tags
Regular (either-sex), DMP and DMAP (antlerless only); Bow/Muzz tags are not valid

NORTHERN ZONE	
Early Bowhunting--All WMUs	Sept. 27 - Oct. 20
Crossbow	Oct. 11 - Oct. 20
Regular	Oct. 21 - Dec. 3
Late Bowhunting--Only WMUs 5A, 5G, 5J, 6A, 6C, 6G, and 6H	Dec. 4 - Dec. 10
SOUTHERN ZONE	
Early Bowhunting	Oct. 1 - Nov. 17
Crossbow--Not in WMUs 4J or 8C	Nov. 4 - Nov. 17
Regular (opens Saturday)	Nov. 18 - Dec. 10
Late Bowhunting	Dec. 11 - Dec. 19 & Dec. 26 - Jan. 1
WESTCHESTER COUNTY (3S)	
Regular--Bowhunting Only	Oct. 1 - Dec. 31
SUFFOLK COUNTY (1C)	
Regular--Bowhunting Only	Oct. 1, 2023 - Jan. 31, 2024
Special Firearms-Permit Req.	Jan. 7 - Jan. 31, 2024
Antler Point Restrictions	
During all seasons, antlered bucks must have at least one antler with 3 or more points that are at least 1 inch long. Young hunters (ages 12-16) are exempt.	
No Deer Hunting	

Early Antlerless Season Sept. 8 - 17
Tags: DMP and DMAP
Vertical Bow-Only: 1C, 3S, 4J, 8C
Firearms, Bow, & Crossbow: 3M, 3R, 8A, 8F, 8G, 8J, 8N, 9A, and 9F

Crossbows
May be used to hunt deer during the Northern and Southern Zone Regular seasons.
May not be used to hunt deer:
- during the Youth Firearms Season; or
- anytime in WMUs 1C (Suffolk County), 3S (Westchester County), 4J or 8C.

2023 MUZZLELOADING DEER SEASONS

Hunting Hours:
30 minutes before sunrise to 30 minutes after sunset

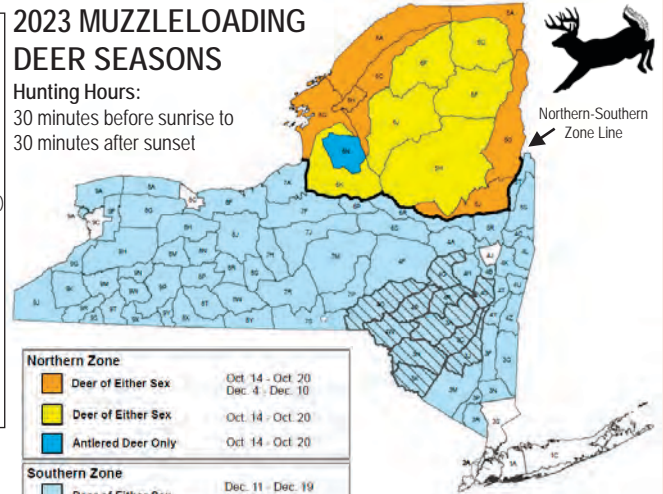

Northern Zone	
Deer of Either Sex	Oct. 14 - Oct. 20 Dec. 4 - Dec. 10
Deer of Either Sex	Oct. 14 - Oct. 20
Antlered Deer Only	Oct. 14 - Oct. 20
Southern Zone	
Deer of Either Sex	Dec. 11 - Dec. 19 Dec. 26 - Jan. 1
Antler Point Restrictions	
During all seasons, antlered bucks must have at least one antler with 3 or more points that are at least 1 inch long. Young hunters (ages 12-16) are exempt.	
No Muzzleloading Season	

Crossbows
May be used to hunt deer during the Northern and Southern Zone Muzzleloader seasons.
May not be used to hunt deer anytime in WMUs 1C (Suffolk County), 3S (Westchester County), 4J or 8C.

2023 BLACK BEAR SEASONS

Hunting Hours:
30 minutes before sunrise to 30 minutes after sunset

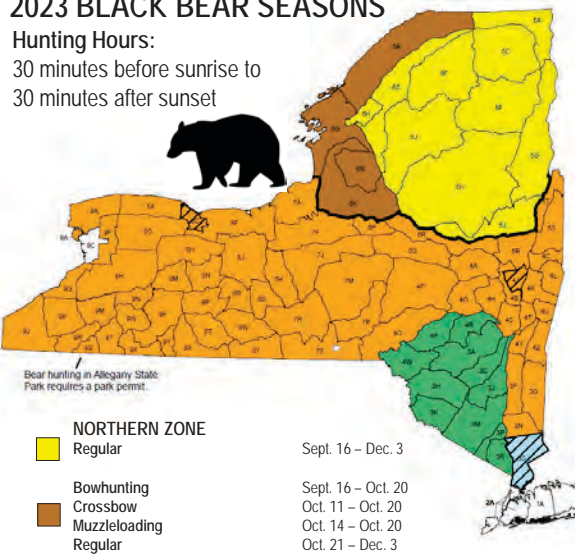

Youth Firearms Season
Season Dates
Oct. 7 - 9, 2023

Area Open
Northern and Southern Zone, except bowhunting-only WMUs

Eligible Hunters
Youth 14-15 years

NORTHERN ZONE	
Regular	Sept. 16 - Dec. 3
Bowhunting	Sept. 16 - Oct. 20
Crossbow	Oct. 11 - Oct. 20
Muzzleloading	Oct. 14 - Oct. 20
Regular	Oct. 21 - Dec. 3
SOUTHERN ZONE	
Early Bear	Sept. 9 - Sept. 24
Early Bowhunting	Oct. 1 - Nov. 17
Crossbow - not in WMUs 4J or 8C	Nov. 4 - Nov. 17
Regular	Nov. 18 - Dec. 10
Late Bowhunting	Dec. 11 - Dec. 19
Late Muzzleloading	Dec. 11 - Dec. 19
Westchester County (3S)	
Regular - Bowhunting Only	Oct. 1 - Dec. 31

Bowhunting Only WMUs

No Bear Hunting

Crossbows
- May be used to hunt bear during the early bear seasons, muzzleloader seasons, and the regular firearms seasons.
- May not be used to hunt bear anytime in WMUs 3S (Westchester County), 4J or 8C.

FALL AND SPRING TURKEY SEASONS

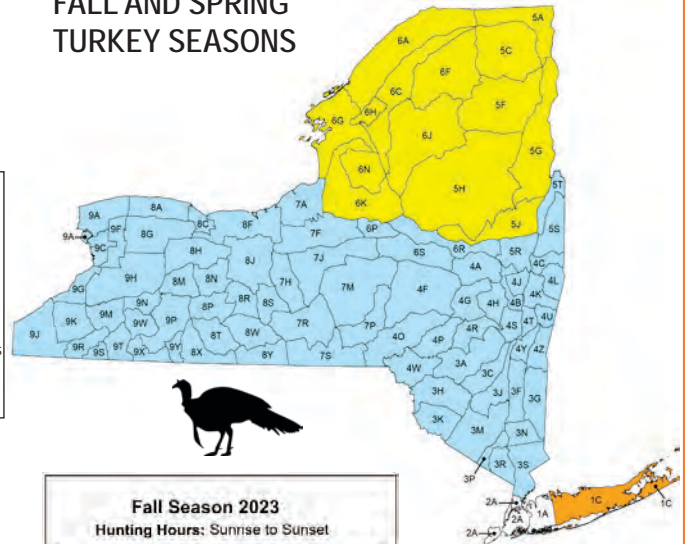

Fall Season 2023	
Hunting Hours: Sunrise to Sunset	
Season Dates:	Statewide Bag Limit:
Oct. 1 - Oct. 14	1 bird of either sex
Oct. 15 - Oct. 28	
Nov. 19 - Dec. 2	
Closed	
Spring Season 2024	
Hunting Hours: 1/2 hour before Sunrise to Noon	
Season Dates:	Statewide Bag
May 1 - May 31	2 bearded birds, no more than 1 in WMU 1C
Closed	

Youth Turkey Season 2024
Hunting Hours:
1/2 hour before Sunrise to Noon
Statewide Bag Limit:
1 bearded bird
Season Dates:
April 20 and 21, 2024
Open Areas:
Same as Regular Spring Season

RUFFED GROUSE HUNTING

Hunting Hours: Sunrise to Sunset

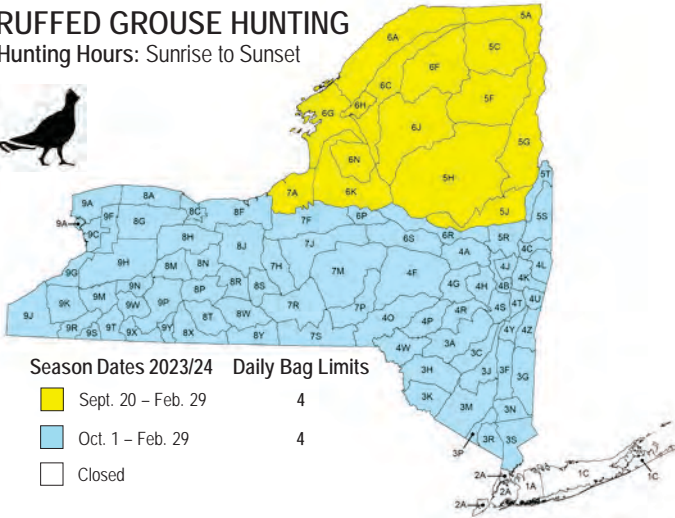

Season Dates 2023/24	Daily Bag Limits
Sept. 20 - Feb. 29	4
Oct. 1 - Feb. 29	4
Closed	

COTTONTAIL RABBIT HUNTING

Hunting Hours: Sunrise to Sunset

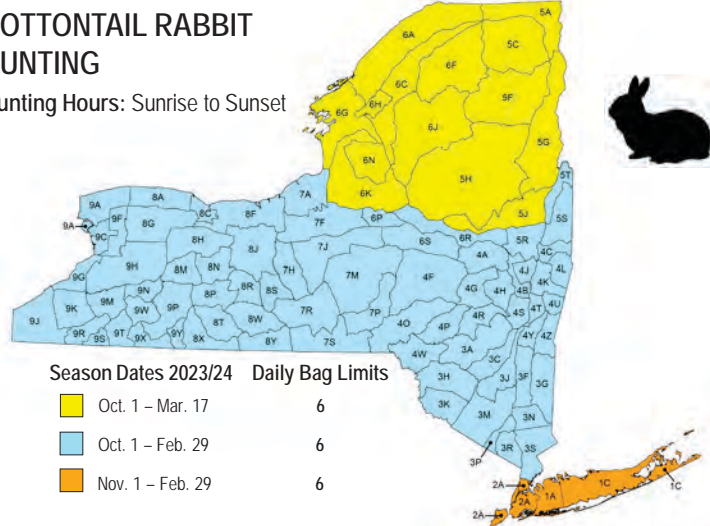

Season Dates 2023/24	Daily Bag Limits
Oct. 1 - Mar. 17	6
Oct. 1 - Feb. 29	6
Nov. 1 - Feb. 29	6

PHEASANT HUNTING

Hunting Hours: Sunrise to Sunset

- Cocks only
- ■ ■ Cocks & hens
- Cocks only east of Shinnecock Canal & Inlet

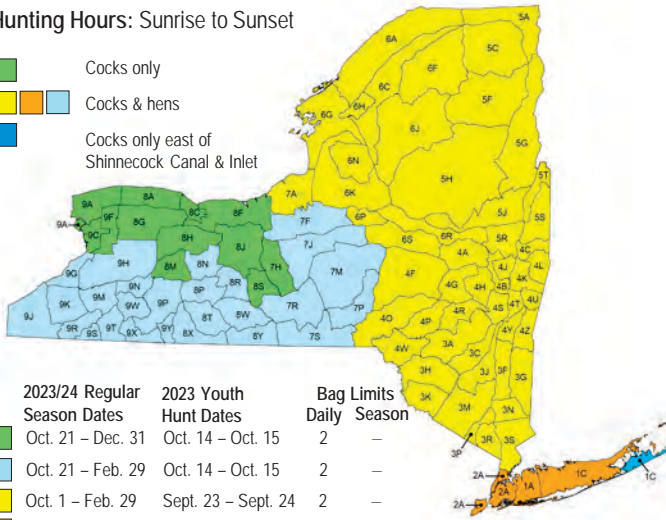

2023/24 Regular Season Dates	2023 Youth Hunt Dates	Bag Limits Daily	Season
Oct. 21 - Dec. 31	Oct. 14 - Oct. 15	2	—
Oct. 21 - Feb. 29	Oct. 14 - Oct. 15	2	—
Oct. 1 - Feb. 29	Sept. 23 - Sept. 24	2	—
Nov. 1 - Dec. 31	Oct. 28 - Oct. 29 [†]	2*/4**	30
Nov. 1 - Dec. 31	Oct. 28 - Oct. 29	2*/4**	30

* Youth Hunt
 ** Regular Season
 † No youth hunt in WMU 2A; hunting is by falconry only

Junior hunters (ages 12-15) must be accompanied by a licensed adult hunter. Only the junior hunter may carry a firearm.

BOBWHITE QUAIL HUNTING

Hunting Hours: Sunrise to Sunset



2023/24 Regular Season Dates	Bag Limits Daily	Season
Oct. 1 - Feb. 29	4	10
Nov. 1 - Dec. 31	6	40
Closed		



RACCOON, FOX, SKUNK, OPOSSUM & WEASEL HUNTING

Long Island: Nov. 1 - Feb. 25

All other areas of New York: Oct. 25 - Feb. 15

There are no bag limits for these species. They may be hunted during the day or night, except weasel, which may only be hunted from sunrise to sunset.



COYOTE HUNTING

Statewide except Long Island and New York City:

Oct. 1 - Mar. 31

There are no bag limits for coyotes. They may be hunted during the day or night.



VARYING HARE HUNTING

Hunting Hours: Sunrise to Sunset

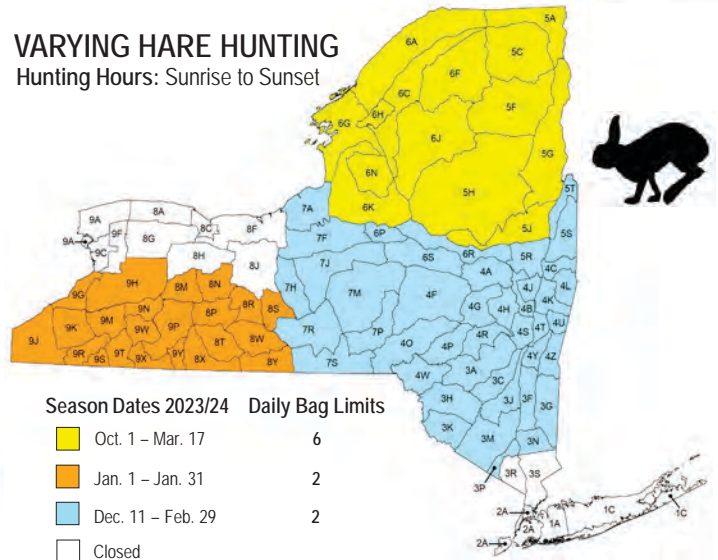

Season Dates 2023/24	Daily Bag Limits
Oct. 1 - Mar. 17	6
Jan. 1 - Jan. 31	2
Dec. 11 - Feb. 29	2
Closed	

GRAY, BLACK & FOX SQUIRREL HUNTING

Daily bag limit of 6 total, regardless of species.

Hunting Hours: Sunrise to Sunset

Long Island: Nov. 1 - Feb. 29

All other areas of New York: Sept. 1 - Feb. 29



Red squirrels are unprotected, and may be hunted at any time without limit.

BOBCAT HUNTING

Hunting Hours:

After sunrise on opening day; and at any hour, day or night, for the rest of the open hunting season.

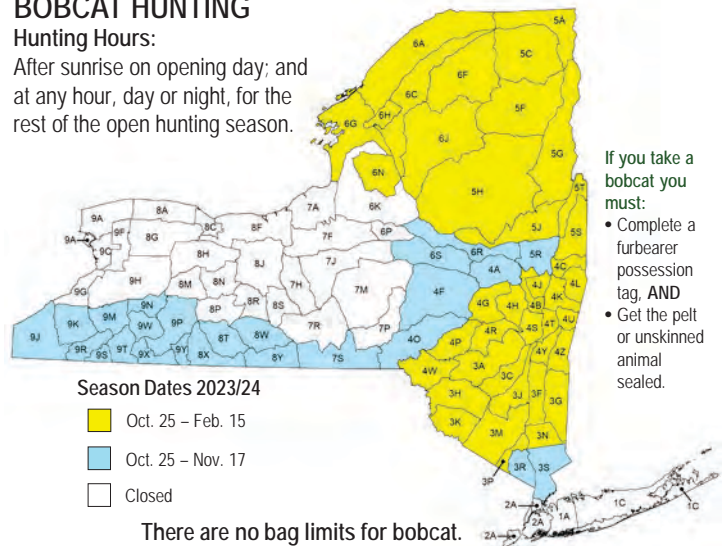

Season Dates 2023/24	Daily Bag Limits
Oct. 25 - Feb. 15	6
Oct. 25 - Nov. 17	6
Closed	

If you take a bobcat you must:

- Complete a furbearer possession tag, AND
- Get the pelt or unskinned animal sealed.

There are no bag limits for bobcat.

BOBCAT TRAPPING

There are no bag limits.

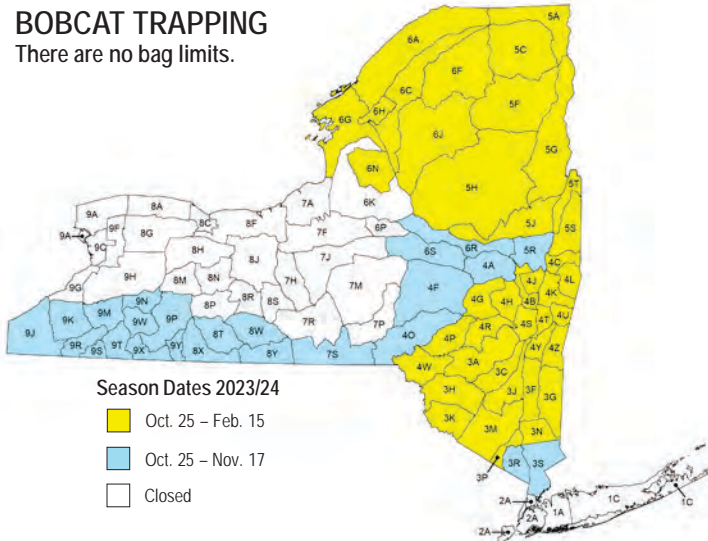

RIVER OTTER TRAPPING

There are no bag limits.

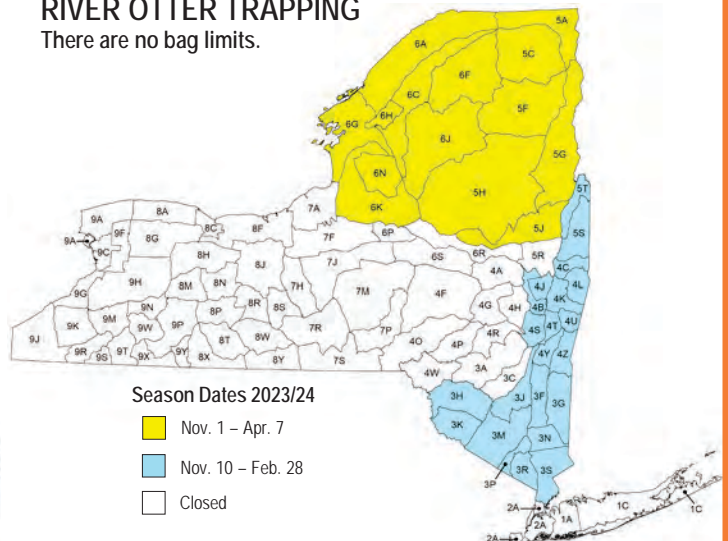

If you take a bobcat, otter, fisher, or marten, you must:

- Complete a furbearer possession tag, AND
- Get the pelt or unskinned animal sealed.

RACCOON, RED FOX, GREY FOX, SKUNK, COYOTE, OPOSSUM & WEASEL TRAPPING

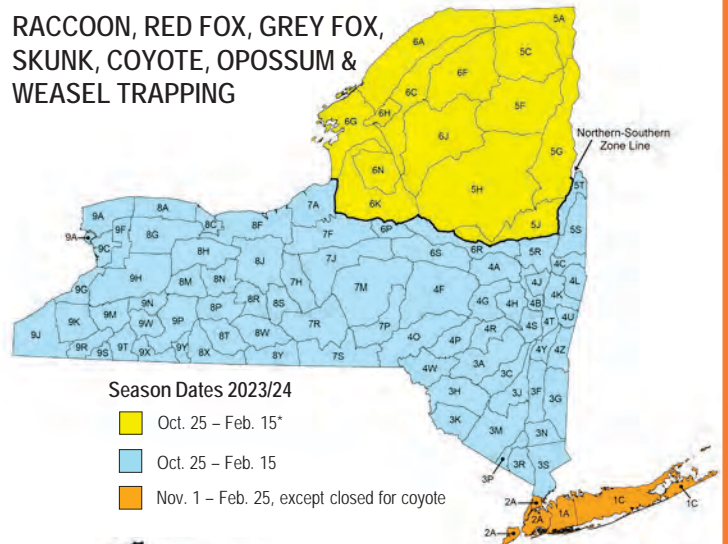

FISHER & MARTEN TRAPPING

To trap marten, you must obtain a special free trapping permit from a Regional Wildlife Office.

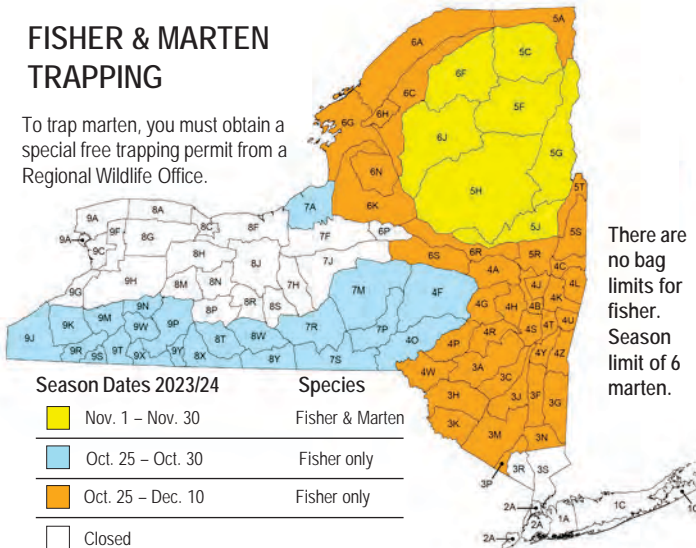

There are no bag limits for fisher. Season limit of 6 marten.



There are no bag limits for these species.

*In the Northern Zone, body-gripping traps set on land may not be set with bait or lure if the fisher and marten season is closed.

BEAVER TRAPPING

There are no bag limits.

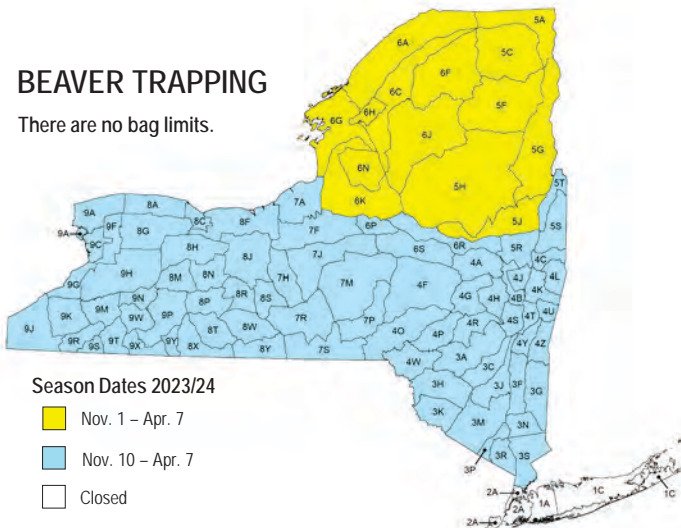

MINK & MUSKRAT TRAPPING

There are no bag limits.

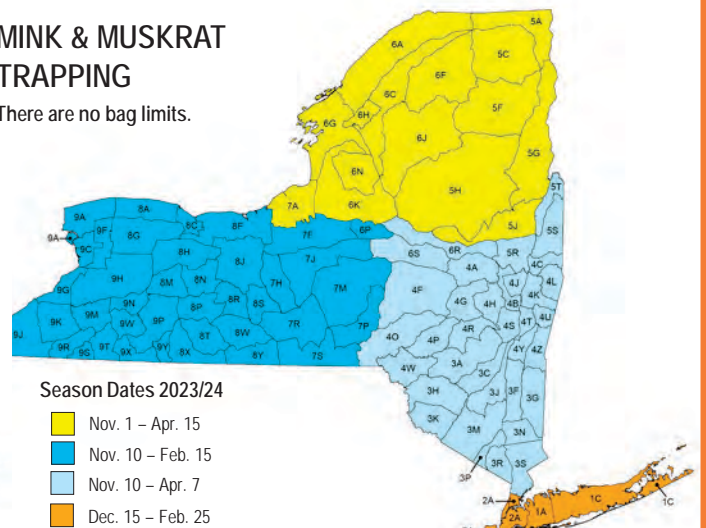

2023-2024 CANADA GOOSE SEASONS

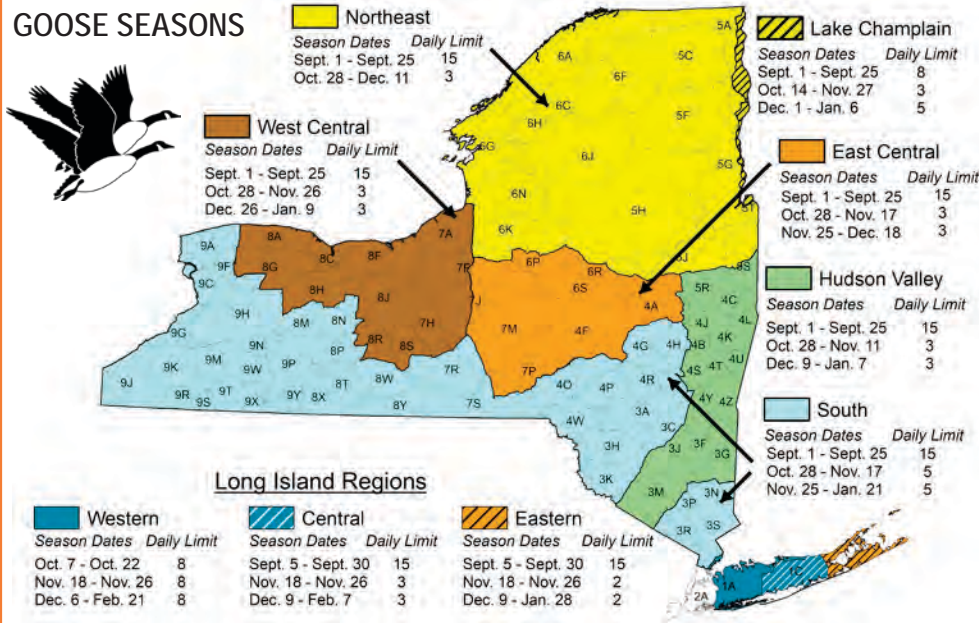

WOODCOCK

Oct. 1 - Nov. 14

Closed

CROW

Sept. 1 - Mar. 31
(Fridays, Saturday, Sundays & Mondays Only)

Closed

2023-2024 WATERFOWL SEASONS

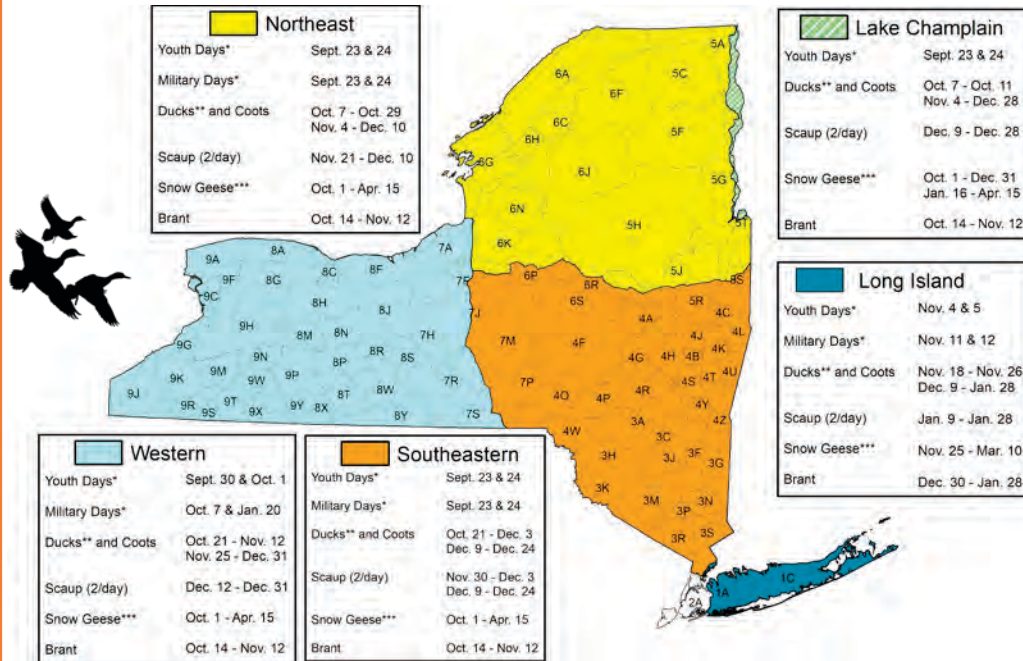

SNIPE, RAILS AND GALLINULES

Sept. 1 - Nov. 9

Closed

A migratory duck stamp is not required to hunt these three groups of birds.

HIP registration is required for each of these species except crow. To register: www.newyorkhip.org or 1-888-427-5447.



* Youth hunters, 12 to 15 years of age, possessing a junior hunting license and HIP registration, may hunt ducks, mergansers, Canada geese, brant, gallinules, and coot on two (2) special days in each zone. Daily bag limits are the same as those allowed during the regular hunting season for all species. Youth hunters must be accompanied by a licensed (including current HIP registration and duck stamp) adult hunter, and the mentor may not carry a firearm. This prohibition does not apply to other hunters in the party that are not mentoring the youth.

** Crippled sea ducks may be taken under power in the Special Sea Duck area, only. The Special Sea Duck Area is defined as the coastal waters of New York State and all waters of streams and rivers seaward from the first upstream bridge.

*** Snow goose seasons include both the regular hunting season and the Conservation Order that runs from January 16 - April 15 in all zones (except Long Island).

Bag Limits

Species	Daily Limit	Possession Limit
Ducks ^a	6	18
Coot	15	45
Canada Geese ^b	See Map	3 times the daily limit
Snow Geese ^b	25	No Limit
Brant	1	3

The daily bag limit is the maximum number of birds of each species that any person may take or possess in the field during any one day. The possession limit is three times the daily bag limit for all migratory game birds except snow geese.

a. The daily limit of 6 ducks includes all mergansers and sea ducks (scoters, eiders and long-tailed ducks) and may include no harlequin ducks and no more than 4 mallards (2 of which may be hens), 3 wood ducks, 2 black ducks, 1 pintail, 1 scaup (2 scaup are allowed during the 20 days specified above for each zone), 2 redheads, 2 canvasback, or 4 sea ducks (including no more than 3 scoters, 3 long-tailed ducks, or 3 eiders and no more than 1 female eider). For all other duck species, the daily limit is no more than 6.

b. Cackling geese and white-fronted geese may be taken a part of the Canada goose daily and possession limits. Snow geese and Ross' geese may be taken as part of the snow goose limits.

The Partnership Between Hunter and Hound

By John Jarzynski

“Did you load the hounds in the truck?” Of the many chores I had as a kid (and those I didn't get to) “loading the hounds in the truck” was one I actually enjoyed. It meant that I was going to spend the day with Dad and a pack of beagles.

I was ever so fortunate to grow up in a family that raised beagles. In a world before cell phones and most video games, beagles were my entertainment. Their unconditional joy and cheerful disposition never failed to put a smile on my teenage face.

Fast forward forty-five years and that smile endures. If I ever need a reminder that someone could enjoy rabbit hunting more than me, I need look no further than the four barking dogs in my kennel or their wiggling tails. It is their dedication to their purpose that has drawn me to them for all these years. They love what they do. It's what is pure about all hunting dogs: their love for what they were bred to do. It's clear to see each time we collar up the dogs on the tailgate. Their undulating bodies shake and shimmy, begging to begin their task. It's electric.

Here in New York State, we are fortunate to have a small game season that lasts through the month of February and even into March. As a result, cold, late winter mornings will find me, along with a few hearty souls listening to the enchanting sounds of a pack of barking hounds as they pursue a cottontail through arrowwood or a snowshoe hare across alder swamps. While technology has changed in the way we track our hounds from the days when my father and his father hunted with beagles, what remains constant is the relationships between hunter and hound and nature. And while the harvesting of game is still the goal, it sometimes takes a backseat to enjoying the sounds of the hunt for this old beagler.

Like today, three hounds are currently bellowing and bawling a few hundred yards away. It echoes through the valley and becomes a musical symphony for all to hear. Unabashed and free, the hounds sing their melody into the February sky warming the hearts of the four brave souls who joined me today.

I marvel at these hounds.

Though each hound has its own subtle personality, tis true: some like to lead while others prefer to make corrections from the back of the pack. Some dogs are more liberal with their barking than others. Ideally, the pack should work in unison, so that when one dog falters or loses the line, the next dog makes the correction, and the run continues with dogs weaving in and out as a dance company or a chorus line. The number of dogs varies depending on scenting conditions and hound availability. Two to five is preferred.

Our three beagles were headed back in my direction. Another miss by me would mean more good-natured ribbing from my hunting partners for sure. As the barking grew louder it was clear that this rabbit would be headed in my direction. I unholstered my Thompson Contender .410 pistol and steadied my feet (rabbits have acute hearing and a good shot is often thwarted by the shuffling feet of a nervous hunter).

John J. and Jack B. with their successful hunt thanks to beagles Mabel and Joe Pickett.



John Jarzynski is the VP of NorthEast Beagle Gundog Federation, an AKC beagle field trial judge, a member of New York Outdoor Writers Association (NYSOWA) and award winning author of two books: *Tally Ho: Confessions of an Old Beagler* and *Beagle Boy: A Lifetime with Hunting Dogs*.



From left to right: Peter D. with beagle, Josie; Quentin J. with beagles Joe Pickett and Mabel; and John J. with beagle Terlingua.

“Don't look in the direction of the hounds. Look in front of the hounds.” Words my father repeated some 45 years ago still ring true each hunt.

A flash of fur, some dazzling rabbit footwork and a blur, and this rabbit was across the path with nary a shot from me. This brought me to laughter. What a joyful moment as the three hounds in hot pursuit followed right behind, their long ears scooping up the fresh scent of rabbit and the chase continued.

“Something wrong with your gun?” asked my friend Pete.

“Maybe it's time for new glasses,” chided another friend.

All ribbing humbly accepted as we laughed and joked about the day. Fortunately, Pete was able to harvest the rabbit after another circle and my rabbit jambalaya dinner plans would remain.

We emptied our guns and loaded the tired hounds onto the tailgate where they lapped water, then stepped into the safety of their dog box, weary but proud. This intrinsic partnership between hunter and hound exists quite naturally. It is a relationship nurtured and celebrated by both hound and hunter each hunting season. It's a winsome work of art and I've been in the front row my whole life.

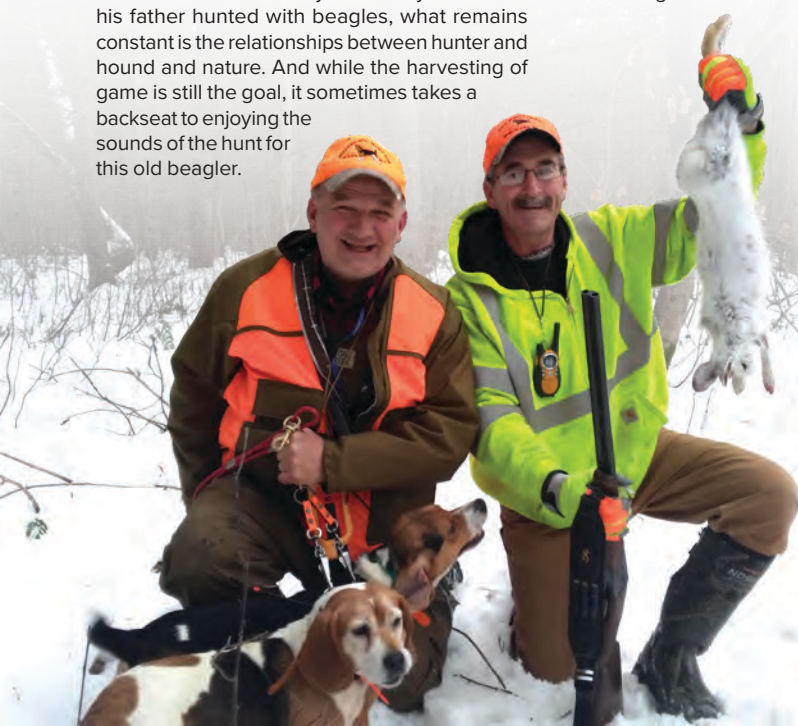

Small Game Hunting

Small game includes upland and migratory game birds, small game mammals, certain furbearers, and reptiles and amphibians.

Please read general hunting regulations first on page 14.

General Regulations

- You may not use a rifle or handgun to hunt pheasant or migratory game birds. See page 48 for more information on turkeys.
- See pages 51–52 for additional information on migratory game birds.
- Air guns (see page 14) may be used to hunt squirrels, rabbits, hares, ruffed grouse, furbearers that may be hunted (e.g., raccoons and coyotes), and unprotected species (see page 15). Air guns may not be used to hunt waterfowl, pheasant, wild turkey, or big game.
- Crossbows may not be possessed afield in the Northern Zone when hunting small game (except coyotes) with the aid of a dog or when accompanied by a dog. Crossbows may be used to take any other small game or game birds during their respective open seasons except in Westchester and Suffolk counties.
- In WMU 2A, hunting is permitted by falconry only.

Reptiles and Amphibians

Frogs—“Frogs” are defined as eastern spadefoot toad, eastern American toad, Fowler’s toad, northern cricket frog, northern gray treefrog, northern spring peeper, western chorus frog, bullfrog, green frog, mink frog, wood frog,

northern leopard frog, southern leopard frog, and pickerel frog.

A fishing or hunting license is required to take frogs with a spear, club, hook, or by hand.

Reptile and Amphibian Hunting Seasons	
Frogs	
Open Season	June 15–Sept. 30
Open Area	All WMUs except that (1) leopard frogs shall not be taken in WMUs 1A, 1C, or 2A; and (2) northern cricket frogs and eastern spadefoot toads shall not be taken in any area of the state.
Size Limit	None
Daily Bag	None
Season Bag	None
Hunting Hours	Any time of the day or night, except that no person shall use a gun to take frogs when hunting at night (sunset to sunrise).
Snapping Turtles	
Open Season	July 15–Sept. 30
Open Area	Statewide
Size Limit	The upper shell (carapace) must be 12 inches or longer, measured in a straight line.
Daily Bag	5
Season Bag	30
Hunting Hours	Any time of the day or night

A hunting license is required to take frogs with a gun, bow, or crossbow.

Snakes, Lizards, and Salamanders—You may not harvest, take, or possess any native snakes, lizards, or salamanders at any time.

Turtles—The only turtle species for which there is an open hunting season is the snapping turtle. You may not harvest, take, or possess any other turtle species at any time.

You may not take or possess diamondback terrapins at any time.

Snapping turtles—A hunting license is required to take snapping turtles. The only legal implements for taking snapping turtles are a gun, bow, or crossbow.

If you choose to eat snapping turtles, you should carefully trim all fat and discard fat, liver, and eggs prior to cooking to reduce exposure to contaminants. For information on these health advisories, call 1-800-458-1158 or visit the website www.health.ny.gov/environmental/outdoors/fish/health_advisories/advice_on_eating_game.htm.

Possession and Release of Game Birds

It is illegal to possess or release migratory game birds and upland game birds without the proper license(s) from DEC. Before you take

Spruce Grouse vs. Ruffed Grouse

In New York State, the spruce grouse is endangered and is not legal to hunt. Spruce grouse occur in evergreen forests in the Adirondacks in Wildlife Management Units 5C, 5F, 6F, and 6J. During the fall, spruce grouse frequently make their way to roads to eat gravel and often travel into upland hardwood forests where ruffed grouse occur. Small game hunters in the Adirondack region must be able to distinguish between these species so that spruce grouse are not shot by mistake.

Spruce grouse are similar in size and color to ruffed grouse, making distinguishing between them difficult. One notable difference is that spruce grouse have an orangish-brown band at the tip of their tails, which contrasts with ruffed grouse’s black tail band. By noting the differences in the images here, small game hunters can avoid accidentally shooting a spruce grouse. The loss of a single female spruce grouse could be a significant setback for a small local population.

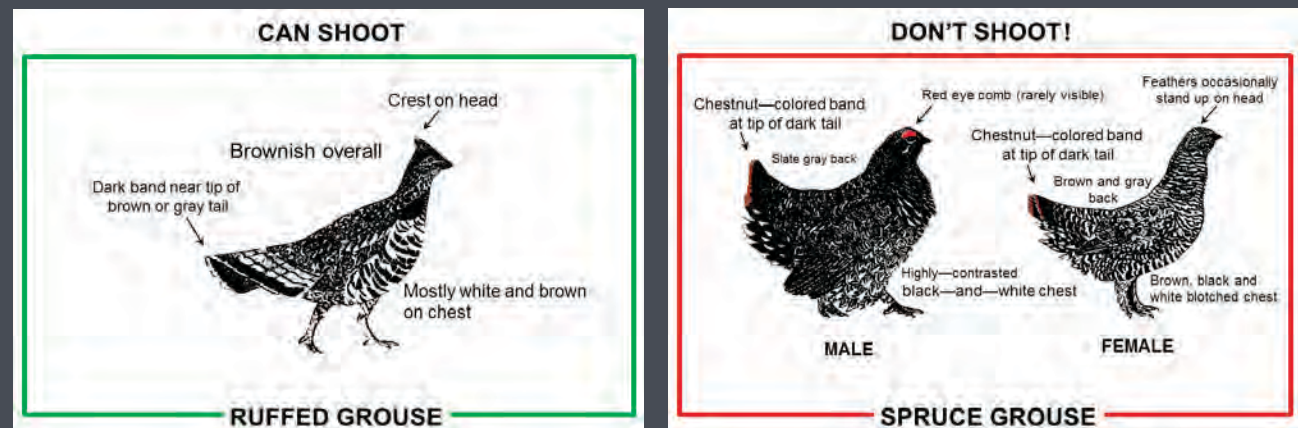

possession of any captive-reared or wild game birds, contact the DEC Special Licenses Unit, 625 Broadway, Albany, NY 12233-4752, or call 518-402-8985, or email speciallicenses@dec.ny.gov.

Falconry Seasons

To hunt small game species with trained raptors, you must possess a Falconry License and a hunting license. Licensed falconers may take small game from October 1 through March 31 in any area of the state open to hunting these species except:

- Common crow may only be taken during the open firearms season.
- A licensed falconer may take both male and female pheasants anywhere in the state when hunting under a Falconry License.

Waterfowl may be taken via falconry during the following seasons:

- **Northeast, Southeast, and Western Waterfowl Zones:** Oct. 1–Jan. 13
- **Long Island Waterfowl Zone:** Nov. 1–Feb. 13
- **Lake Champlain Waterfowl Zone:** Only during the regular hunting season for each species (see map on page 49).

For more information on falconry, contact the DEC Special Licenses Unit, 625 Broadway, Albany, NY 12233-4752, or call 518-402-8985.

Use of Hunting Dogs

Dogs may be used to hunt small game, except:

- You may not use dogs to hunt wild turkey in the spring.
- In the Northern Zone, if you are hunting with a dog, or accompanied by a dog, you may not possess a rifle larger than .22-caliber rimfire or possess a shotgun loaded with slug, ball, or buckshot unless you are coyote hunting with a dog. In the Northern Zone, crossbows may not be possessed afield when hunting small game (except coyotes) with the aid of a dog or when accompanied by a dog.

Training

You may train dogs on raccoon, fox, coyote, and bobcat from July 1 through April 15. You may train dogs on other small game only from August 15 through April 15. You may train dogs at any time on lands you own, lease, or have written permission to use, if you are not training on wild game. You may only use blank ammunition when training dogs, except during an open season.

Control

Hunting dogs should remain under control of the hunter or trainer, especially on lands inhabited by deer. Do not allow your dogs to pursue game on any posted land without the landowner's permission. Do not shoot dogs; report stray dogs to a local Environmental Conservation Officer (ECO) or your local animal control officer.

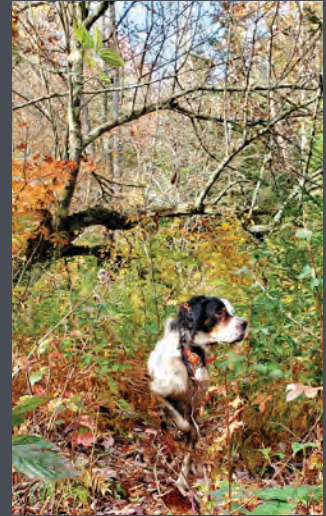

Mike S's dog Bump in action

Small Game Hunting

Protect Rabbits and Hares from RHDV2

Rabbit hemorrhagic disease virus 2 (RHDV2) is highly lethal to rabbits and hares. It is easily transmitted through direct contact between rabbits or contact with contaminated objects. RHDV2 is extremely hardy, remaining contagious on surfaces for 3 months. If it enters NY's wild rabbit and hare populations, it will be impossible to control and could result in significant population declines. To protect these species:

- Avoid contact with domestic rabbits.
- Wear disposable gloves when handling rabbit and hare carcasses.
- Properly dispose of rabbit carcasses in trash that's taken to a landfill or by burying deep enough to prevent scavenging.
- Disinfect all hunting gear after out-of-state travel with a 10% bleach solution (1 part household bleach, 9 parts water).
- Avoid travel to states that have confirmed RHDV2 outbreaks, and do not bring rabbit carcasses killed in other states to New York.
- Avoid transporting rabbits or hares to train hunting dogs.
- Although dogs cannot get sick from RHDV2, they can transmit the virus, so minimize contact between dogs and rabbit carcasses.
- Immediately report sick rabbits or unusual rabbit mortalities to DEC's Wildlife Health Program (518-478-2203; wildlife@dec.ny.gov).

Hunters: You Can Help Combat the Illegal Wildlife Trade

One of the biggest threats to New York's turtles is illegal collection. What to look for: people with bags poking around wetlands and streams; unmarked traps in wetlands (a trap set for legitimate purposes will be clearly labeled); sheets of metal/plywood laid out on the ground to attract reptiles; cars with collection equipment like nets, containers, pillowcases visible inside; unattended backpacks/bags left in the woods along a trail or road. If you see or hear about suspicious behavior that may be connected to poaching call DEC Law Enforcement - 1-844-DEC-ECOS. The U.S. Fish and Wildlife Service (USFWS) also has an anonymous tip line - 1-844-FWS-TIPS. For more visit: www.fws.gov/story/how-report-wildlife-crime.

Cottontail Rabbit Hunting

Hunting Hours: Sunrise to Sunset

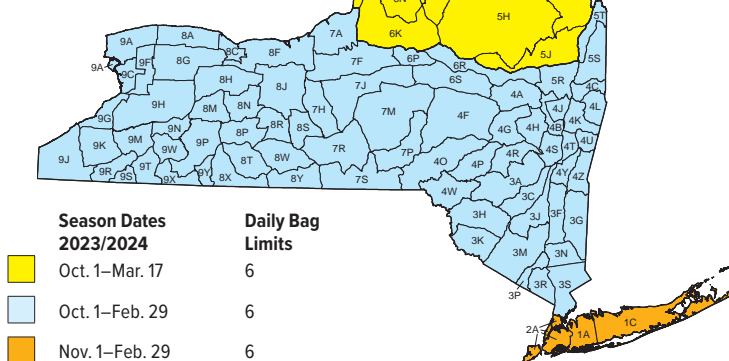

Varying Hare Hunting

Hunting Hours: Sunrise to Sunset

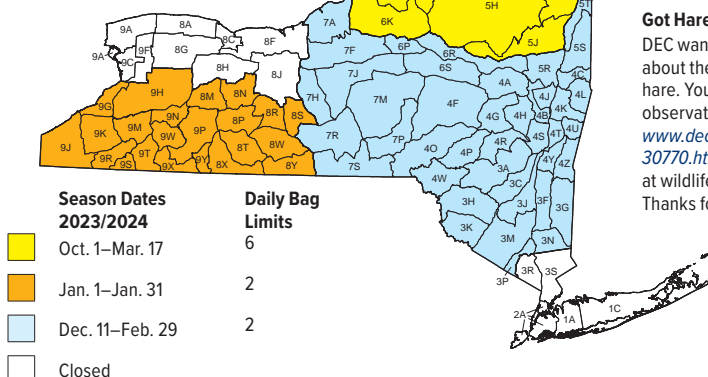

Got Hare?

DEC wants to learn more about the distribution of hare. You can report your observations online at www.dec.ny.gov/animals/30770.html or email us at wildlife@dec.ny.gov! Thanks for your help!

Gray, Black & Fox Squirrel Hunting

Hunting Hours: Sunrise to Sunset

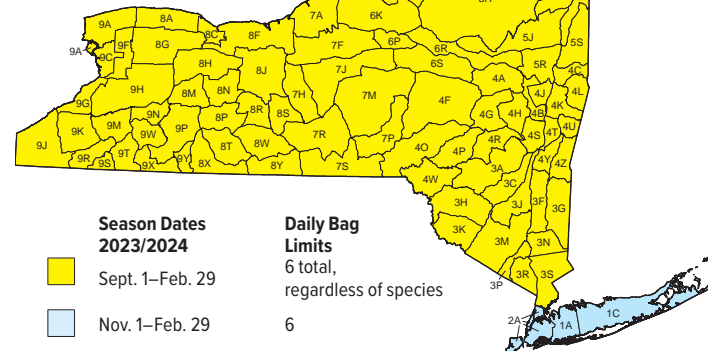

Pheasant Hunting

Hunting Hours: Sunrise to Sunset

- Cocks only
- ■ ■ Cocks & hens
- Cocks only east of Shinnecock Canal & Inlet

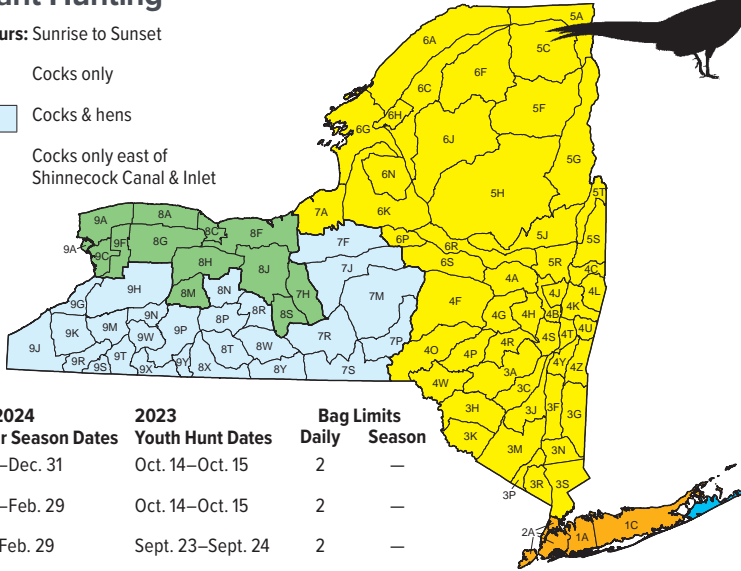

2023/2024 Regular Season Dates	2023 Youth Hunt Dates	Bag Limits	
		Daily	Season
■ Oct. 21–Dec. 31	Oct. 14–Oct. 15	2	—
■ Oct. 21–Feb. 29	Oct. 14–Oct. 15	2	—
■ Oct. 1–Feb. 29	Sept. 23–Sept. 24	2	—
■ Nov. 1–Dec. 31	Oct. 28–Oct. 29 [†]	2*/4**	30
■ Nov. 1–Dec. 31	Oct. 28–Oct. 29	2*/4**	30

* Youth Hunt
 ** Regular Season
[†] In WMU 2A no youth hunt; hunting is by falconry only

Bobwhite Quail Hunting

Hunting Hours: Sunrise to Sunset

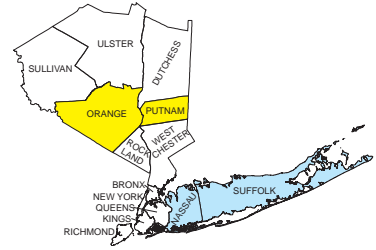

2023/2024 Season Dates	Bag Limits	
	Daily	Season
■ Oct. 1–Feb. 29	4	10
■ Nov. 1–Dec. 31	6	40
■ Closed		

Where does DEC stock pheasants?

In 2022, DEC launched an interactive mapper that shows where pheasants are released throughout New York. Please note that many of these lands are privately owned and pheasant stocking is only permitted with the participation of landowners. Be sure to respect the land and any special rules that may be in place. To view the map, visit: www.dec.ny.gov/outdoor/8363.html

Grouse Hunters Needed!



Easy as 1-2-3!

- 1 Collect 1 central tail feather
- 2 Pluck 2-5 rump feathers
- 3 Collect outer 3 wing feathers

DEC is embarking on a study of ruffed grouse age and sex composition. You can help by sending a sample of rump, wing, and tail feathers from all NY harvested ruffed grouse.

To request more information and supplies, please call 518-402-8929 or email wildlife@dec.ny.gov.

Ruffed Grouse Hunting

Hunting Hours: Sunrise to Sunset

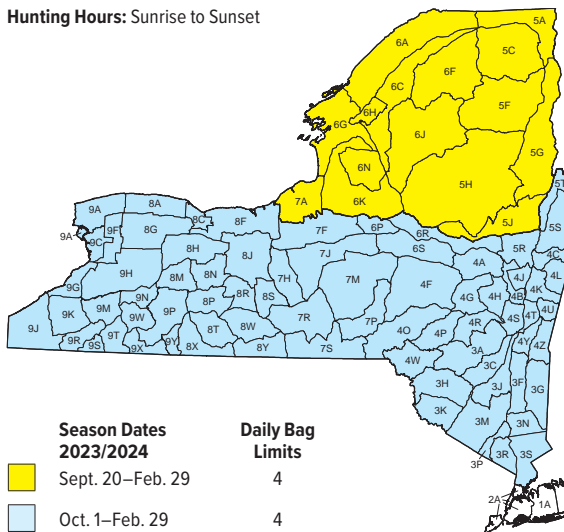

2023/2024 Season Dates	Daily Bag Limits
■ Sept. 20–Feb. 29	4
■ Oct. 1–Feb. 29	4
■ Closed	

Must register with Harvest Information Program (HIP) to shoot woodcock:
<https://www.newyorkhip.org/>
 or 1-888-427-5447

Turkey Hunting

General Regulations

- You may buy only one turkey permit per year, which includes three carcass tags, two for spring and one for fall.
- If you have filled your bag limit, you may call turkeys for another hunter, but you may not carry a bow, crossbow, or firearm. You may call turkeys to aid another hunter only if you are licensed to hunt wild turkey in New York and have a valid turkey permit.
- If you have taken a turkey that is unfit for consumption, authorized DEC staff may issue a special permit to take another. You will have to surrender the carcass. Call your wildlife or law enforcement office (see page 6).

Turkey Hunters Needed for Grouse Survey

DEC is seeking spring turkey hunters to participate in a survey to help monitor grouse populations.

For more information:

- Email us at wildlife@dec.ny.gov and type "Grouse Drumming Survey" in the subject line, or
- Call 518-402-8883, or
- Visit www.dec.ny.gov and search for "drumming survey."

Manner of Taking

- You must carry your hunting license and turkey permit while you hunt.
- You may hunt with a bow or crossbow; however, crossbows may only be used by hunters 14 or older and may not be used to take wild turkeys in Westchester or Suffolk counties.
- You may hunt with a shotgun or handgun only when using shot no larger than #2 and no smaller than #9.
- You may not take a turkey with a rifle or air gun, or with a handgun firing a bullet.
- You may use a muzzleloading shotgun.
- You may not hunt with a dog during the spring season. You may hunt with a dog during the fall season.
- You may not use bait to hunt turkey.
- You may not use an electronic calling or amplifying device to locate or hunt turkeys during the open season.
- You may use decoys. You may not use a live decoy when turkey hunting.
- A scope of any type is allowed.

Tagging, Possession, and Reporting

- Immediately after taking a wild turkey, you must fill out the appropriate carcass tag in ink, mark or cut out the date and month of kill, sign the back, and attach it to the carcass.
- The carcass tag must stay attached to the turkey carcass until it is prepared for eating.
- You may give your turkey to another person.
- You must attach a tag with the following information to the turkey carcass:
 - » Your name
 - » Your address
 - » Your hunting license number
 - » Turkey permit carcass tag number
 - » The recipient's name
 - » The recipient's address
- You must report your harvest within 7 days via phone (1-866-GAMERPT), online (www.dec.ny.gov), or through our HuntFishNY mobile app (see page 8).



Reward

Protect wild turkeys against illegal hunting. Their future depends on you!

The National Wild Turkey Federation is offering a \$200 reward to anyone giving information and testimony leading to the arrest and conviction of anyone illegally hunting or killing a wild turkey in New York State. 1-844-DEC-ECOS



Fall Turkey Season

- You may take a bird of either sex.
- There is one carcass tag for the fall season and it may be used in any fall turkey hunting zone. Immediately after taking a turkey, you must fill out the carcass tag in ink and attach it to the bird.
- **If you take a turkey, save one of its legs.** You will receive instructions about what to do with the leg when you report your harvest. The legs are used for age and sex information.

Spring Turkey Season

- In the spring, you may take two bearded birds. You may only take one bird per day.
- Fill out the carcass tag and attach it to the bird.
- You do not need to save and send in turkey legs in the spring. You do need to take careful spur, beard, and weight measurements for harvest reporting.
 1. Spur measurements: Spurs should be measured from the tip of the spur to the base of the spur, where it emerges from the scaly part of the leg. Measure to the nearest ¼ inch. Do not measure to the forward edge of the leg, only to the base of the spur.
 2. Beard measurements: Beards should be measured from the tip of the beard to the base, where it emerges from the skin. Put the end of your ruler against the base of the beard and extend the beard along the body of the ruler. Measure to the nearest ¼ inch.
 3. Record the weight of the turkey to the nearest pound.

Fall and Spring Turkey Seasons

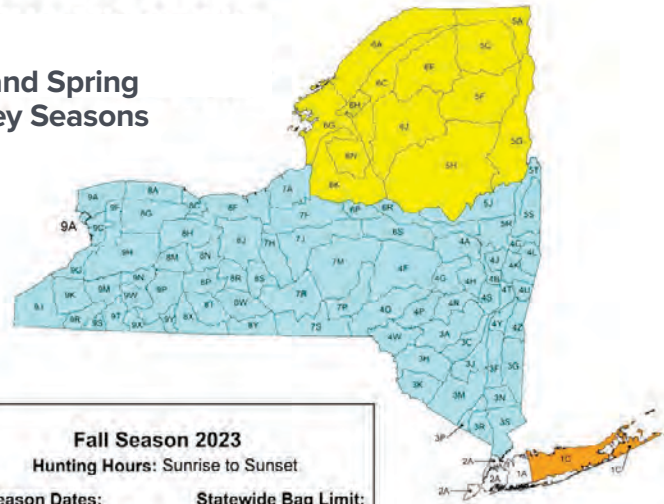

Fall Season 2023	
Hunting Hours: Sunrise to Sunset	
Season Dates:	Statewide Bag Limit:
 Oct. 1 - Oct. 14	1 bird of either sex
 Oct. 15 - Oct. 28	
 Nov. 19 - Dec. 2	
 Closed	
Spring Season 2024	
Hunting Hours: 1/2 hour before Sunrise to Noon	
Season Dates:	Statewide Bag
 May 1 - May 31	2 bearded birds, daily limit of 1, and no more than 1 may be harvested in WMU 1C
 in all open areas	
 Closed	

Youth Turkey Season 2024	
Hunting Hours: 1/2 hour before Sunrise to Noon	
Statewide Bag Limit: 1 bearded bird	
Season Dates: April 20 and 21, 2024	
Open Areas: Same as Regular Spring Season	



A successful hunt for Mandy W., posing with her dogs Boone and Gannet after her hunt.

Turkey Hunting Tips

Successful turkey hunters sit and call.

Don't wear red, white, blue, or black.

Most turkey hunting injuries happen when one hunter stalks another hunter.

DON'T TRY TO STALK TURKEY!

Assume anything that sounds like a turkey is a human (calls, footsteps).

If you see another hunter:

- **Don't** move, wave, or nod.
- **Don't** make turkey or animal sounds.
- **Do** speak up clearly, saying "STOP."

If you see a turkey:

Be 100% sure of your target and beyond. To prevent another hunter from mistaking you for a gobbler, avoid using a turkey reaper fan.

Turkey Hunting

Spring Youth Hunt

Eligible hunters are 12–15 years of age and hold a Junior Hunting License and a Turkey Permit.

All youth hunters must be accompanied by an adult, as required by law for a Junior Hunting License (see pages 36 and 37).

The accompanying adult must have a current hunting license and Turkey Permit. He/she may assist the youth hunter (including calling), but may not carry a firearm, crossbow or bow, or kill or attempt to kill a wild turkey during the youth hunt. Crossbows may only be used by licensees who are 14 years of age or older.

The bag limit for the youth hunt is one bearded bird. This bird becomes part of the youth's regular season bag limit of two bearded birds. A second bird may be taken beginning May 1.

All other wild turkey hunting regulations remain in effect.



A proud father moment with Autym D. after a successful turkey hunt.

Why Do We Have a May 1 Opener?

Research has found that the optimal start date for the spring season is the median date of incubation (when about half of hens are on nests). In New York and much of the Northeast this is around May 1st. A May 1 opener provides the best opportunity to pursue gobblers when they are vocal and responsive to calling while minimizing disruption to reproduction. An earlier season start can disrupt breeding behavior and nesting, negatively affecting long-term turkey abundance and hunt quality.

BE TICK SAFE!

Ticks can spread disease, but not all bites will make you sick. Deer ticks may carry Lyme disease, the most common tick-borne disease in New York.



QUESTIONS?

- Contact the NYS Department of Health or your healthcare provider if you have symptoms of fever, rash, body aches, or fatigue after a tick bite.
- See www.health.ny.gov/diseases/communicable/lyme/

TICK REMOVAL

- Using tweezers, grab the tick as close to your skin as possible.
- Pull upward with steady, even pressure.
- Clean the bite area with soap and water, rubbing alcohol, or hydrogen peroxide.

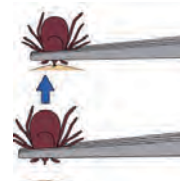

Check yourself, your children, and pets for ticks daily.

What is a Migratory Game Bird?

Under state and federal laws and regulations, all of the following are considered migratory game birds in New York:

- All wild ducks, mergansers, geese, and brant (waterfowl)
- All coot, rails, and gallinules (moorhens)
- Woodcock and snipe

Crows are not considered migratory game birds under federal regulations, but most of New York's migratory game bird hunting regulations apply to crows. You should assume they are the same except where differences are noted.

Mourning doves are considered migratory game birds under federal regulations, but they are not defined as such under New York State law so no hunting season has been established for this species.

Migratory Game Bird Seasons and Bag Limits

Migratory game bird hunting regulations are set by the federal government in consultation with state agencies.

Consumption of Wild Waterfowl

The New York State Department of Health recommends that you remove the skin and fat of wild waterfowl before cooking, and eat no more than two meals containing waterfowl per month (with the exception of mergansers). Mergansers are fish-eating birds that tend to be the most heavily contaminated waterfowl and should not be eaten.

Recent data indicate that waterfowl residing in the Hudson River between Hudson Falls and Troy have higher PCB levels than waterfowl from other portions of the Hudson River and are likely to have higher PCB levels than waterfowl from other areas of the state. Because PCBs may have a greater effect on young children or an unborn child, it is particularly important for women under 50 and children under 15 to minimize their PCB exposure. For more information visit www.health.ny.gov/environmental/outdoors/fish/health_advisories/advice_on_eating_game.htm.

Waterfowl Hunting in Populated Areas

Some excellent waterfowl hunting opportunities occur in shoreline areas of New York that are becoming more populated and developed. Waterfowl hunters have special privileges in New York, but please consider the possible concerns that nearby homeowners may have about noise, safety, or invasion of privacy before you go afield. Avoiding such conflicts will help ensure that waterfowl hunting remains an accepted tradition in fast-developing shoreline areas. For more information, go to www.dec.ny.gov/outdoor/94213.html.

DEC, in cooperation with the South Shore Waterfowlers Association (SSWA), has produced *A Pocket Reference for Police Officers and Waterfowl Hunters* that summarizes the state laws that pertain to waterfowl hunting in general and includes a code of ethics for waterfowl hunters to help ensure that waterfowl hunting remains a viable recreational opportunity in New York. For a copy, call 518-402-8883 or email wildlife@dec.ny.gov.

Snow Goose Conservation Order

Waterfowl hunters in New York will have a special opportunity to harvest snow geese in most areas of the state from January 16 through April 15, 2023. This additional opportunity is offered because of concerns about impacts that snow geese are having on natural ecosystems. For more information, go to www.dec.ny.gov/outdoor/50514.html.

General Regulations

Following is a summary of state and federal rules that apply to the taking, possessing, shipping, transporting, and storing of all migratory game birds in New York. For more complete information, consult the specific federal (50 CFR Part 20) and state (6 NYCRR Part 2.30) regulations. You can find links to both of these at www.dec.ny.gov/outdoor/28175.html.

Definitions

Migratory game birds are wild ducks, geese, brant, coot, rails, gallinules, woodcock, and snipe. Migratory waterfowl are wild ducks, geese, brant, and coot.

License requirements

All migratory game bird hunters must carry a valid New York State hunting license, except for persons not required to have a hunting license. All migratory game bird hunters must register annually with New York's Harvest Information Program (HIP) and carry proof of compliance whenever going afield. If you are 16 years or

older and you hunt waterfowl, then you also need a federal migratory game bird hunting stamp (duck stamp).

Harvest Information Program (HIP) Registration

All migratory game bird hunters must register annually for HIP through DECALS, DEC's licensing system. Information from this survey helps the USFWS and State wildlife agencies monitor the harvest of migratory game birds and is needed to establish hunting regulations. HIP registration is valid from August 1 – July 30 annually. There are two options for registering:

- **Option 1 – Online HIP Registration:**
 - » Go to the DEC Hunting License website: decals.licensing.east.kalkomey.com/
 - » Click on the header at the top of the main page that says "Report Game Harvest/ Register for HIP"
 - » A DECALS login is not required, but you will be prompted to provide your DEC ID and Date of Birth
 - » Click "Search"
 - » The system will then list all previous HIP registrations you have associated with your DEC ID, indicating whether they have been submitted or are still pending.
 - If no results return after pressing the "Search" button, it means you currently do not have a current/valid hunting license and are ineligible for HIP registration.
 - » Once you find the current HIP year registration survey, you will select the dropdown arrow on the right-hand side, and select "Register for HIP"
 - You will be prompted to answer a series of questions pertaining to your hunting activities last year.
 - » After answering all required questions, press "Submit." The system will then save your data and provide your HIP number. This number completes the registration process and proves your participation in HIP. You are required to carry this number with you in some form while migratory bird hunting.
- **Option 2 – HIP Registration via the automated phone system:**
 - » Call 1-866-933-2257
 - » Select the option for "HIP registration"
 - » Follow automated instructions.
 - » At the end of the call, you will be given your HIP registration number. Migratory game bird hunters are required to carry this number in some form while hunting.

Migratory bird hunting stamp

Each waterfowl hunter 16 years of age or older must carry on his/her person a valid Federal Migratory Bird Hunting and Conservation Stamp (duck stamp) signed in ink across the face. Stamps do not have to be attached to your license. E-stamps, validated as defined in the Federal Permanent Electronic Duck Stamp Act of 2013, are also permitted. Duck stamps are not required to hunt coot, rails, gallinules, woodcock, or snipe. Duck stamps are not required of minors 12 to 15 years of age hunting migratory waterfowl in New York State.

Migratory Game Birds

Federal duck stamps are sold at most post offices and many sporting goods stores and cost \$25 each. They may also be ordered by calling 1-800-852-4897. There is a shipping and handling fee for phone or internet orders.

Hunting hours

Woodcock may be taken from sunrise to sunset. All other migratory game birds may be taken from one-half hour before sunrise until sunset in all hunting zones. Canada geese may be taken until one-half hour after sunset during the September seasons, when all other waterfowl hunting seasons are closed. Otherwise, shooting hours end at sunset. Snow geese may be taken until one-half hour after sunset during January 15–April 15 whenever all other waterfowl hunting seasons are closed.

Non-toxic shot requirement

Non-toxic shot is required for hunting any migratory game bird, except woodcock, everywhere in New York State. Possession or use of shells loaded with shot other than steel, bismuth-tin, iron-tungsten, iron-tungsten-nickel, tungsten-bronze, tungsten-iron-copper-nickel, tungsten-matrix, tungsten-polymer, tungsten-tin-iron, tungsten-tin-bismuth, tungsten-tin-iron-nickel, or other shot approved by the U.S. Fish and Wildlife Service is strictly prohibited when hunting waterfowl, snipe, rails, or gallinules.

Duck hunting blinds

NYS Navigation Law Section 33-b requires that duck blinds placed in the waters of lakes within New York State be prominently marked with the owner's full name and address. All duck blinds placed in lakes must be removed no later than March 15 annually.

Prohibitions on methods of take

No person shall take migratory game birds:

- With a trap, snare, net, rifle, pistol, swivel gun, shotgun larger than 10-gauge, punt gun, battery gun, machine gun, fishhook, poison, drug, explosive, or stupefying substance.
- With a shotgun capable of holding more than three shells, unless it is plugged with a one-piece filler that is incapable of removal without disassembling the gun. This does not apply to the taking of snow geese in any area or zone, or taking of Canada geese during September, when all other waterfowl seasons are closed. However, semi-automatic shotguns may not exceed six shells in the magazine and chamber combined, at any time when waterfowl hunting.
- From a sink box (a low-floating device, having a depression affording the hunter a means of concealment beneath the surface of the water).
- From or with the aid or use of a car or other motor-driven land conveyance, or any aircraft, except that paraplegics and single or double amputees of the legs may, with a permit issued by the DEC, take from any stationary motor vehicle or stationary motor-driven land conveyance. "Paraplegic" means an individual afflicted with paralysis of the lower half of the

body with involvement of both legs, usually due to disease or injury to the spinal cord.

- From or by means of any motorboat or sailboat unless the motor has been completely shut off and/or sail furled, and its progress has ceased. Motorboats and sailboats under power may be used to retrieve dead or crippled birds; however, crippled birds may not be shot from such craft under power except in the Special Sea Duck Area described in the Hunting Seasons Table.
- By the use or aid of live decoys. All live, tame or captive ducks and geese shall be removed for a period of 10 consecutive days prior to hunting and confined within an enclosure which substantially reduces the audibility of their calls and totally conceals such tame birds from the sight of migratory waterfowl.
- Using recorded migratory bird calls or sounds or electrically amplified imitations of bird calls. This does not apply to the taking of snow geese in any area or zone, or taking of Canada geese in September, when all other waterfowl seasons are closed.
- By driving, rallying or chasing birds with any motorized conveyance or any sailboat to put them in the range of hunters.
- By the aid of baiting (placing feed such as corn, wheat, salt, or other feed to constitute a lure or enticement) or on or over any baited area. Hunters should be aware that a baited area is considered to be baited for 10 days after the removal of the bait, and it is not necessary for the hunter to know an area is baited to be in violation. Migratory game birds may be taken on or over standing crops, flooded harvested crop lands, or grain crops properly shocked on the field where grown or grains are found scattered solely as a result of the normal agricultural planting or harvesting.

Military and Veteran Hunting Days

Military veterans or active duty hunters possessing the necessary licenses, HIP registration, and duck stamp, may hunt migratory game birds during two (2) special days in each zone. The daily bag limit is the same as those allowed during the regular hunting season.

In addition to the previously mentioned license requirements for adults hunting migratory game birds, participants must carry one of the following forms of identification afield:

- Active military identification card
- Actively participating Guard or Reservist identification card
- Retired military identification card
- New York State drivers license with Veteran Status
- Form DD214, Certificate of Discharge
- Form DD215, Corrected Certificate of Discharge

Wanton waste and possession of live birds

No person shall kill or cripple any migratory game bird without making a reasonable effort to retrieve the bird and retain it in his/her actual custody. Wounded birds reduced to possession

shall be killed immediately and included in the daily bag limit.

Field possession limit

No more than one daily bag or aggregate daily bag limit of migratory game birds may be possessed or transported, tagged or untagged, at or between the place of taking and:

- His or her automobile or principal means of land transportation
- His or her personal abode or temporary place of lodging
- Migratory bird preservation facility
- Post office or common-carrier facility

No person shall completely field dress any migratory game bird and then transport the bird from the field. The head or one fully feathered wing must remain attached to all such birds while being transported.

Possession, tagging, shipment, and importation

The possession limit is the maximum number of migratory game birds that any person may possess in total in his/her automobile or principal means of land transportation, personal abode, or in his/her name at any migratory bird preservation facility, post office, or common-carrier facility. The possession limit is three times the daily bag limit for all waterfowl species except snow geese.

No person shall give, put, or leave any migratory game birds at any place (other than personal abode) or in the custody of another person for picking, cleaning, processing, shipping, transportation, storage (including temporary storage), or taxidermy services, unless the birds are tagged by the hunter with the following information:

- Hunter's name, address, and signature
- Total number of birds involved, by species
- Dates such birds were killed

For more information on regulations pertaining to possession, tagging, shipment, and importation of legally killed migratory game birds, consult the specific federal and state regulations cited above.

Caution/dual violation

More restrictive regulations may apply to national wildlife refuges and state WMAs open to public hunting. Violation of New York State migratory bird hunting regulations is also a violation of federal regulations.



Migratory Game Bird Hunting Seasons and Bag Limits

2023–2024 Waterfowl Seasons

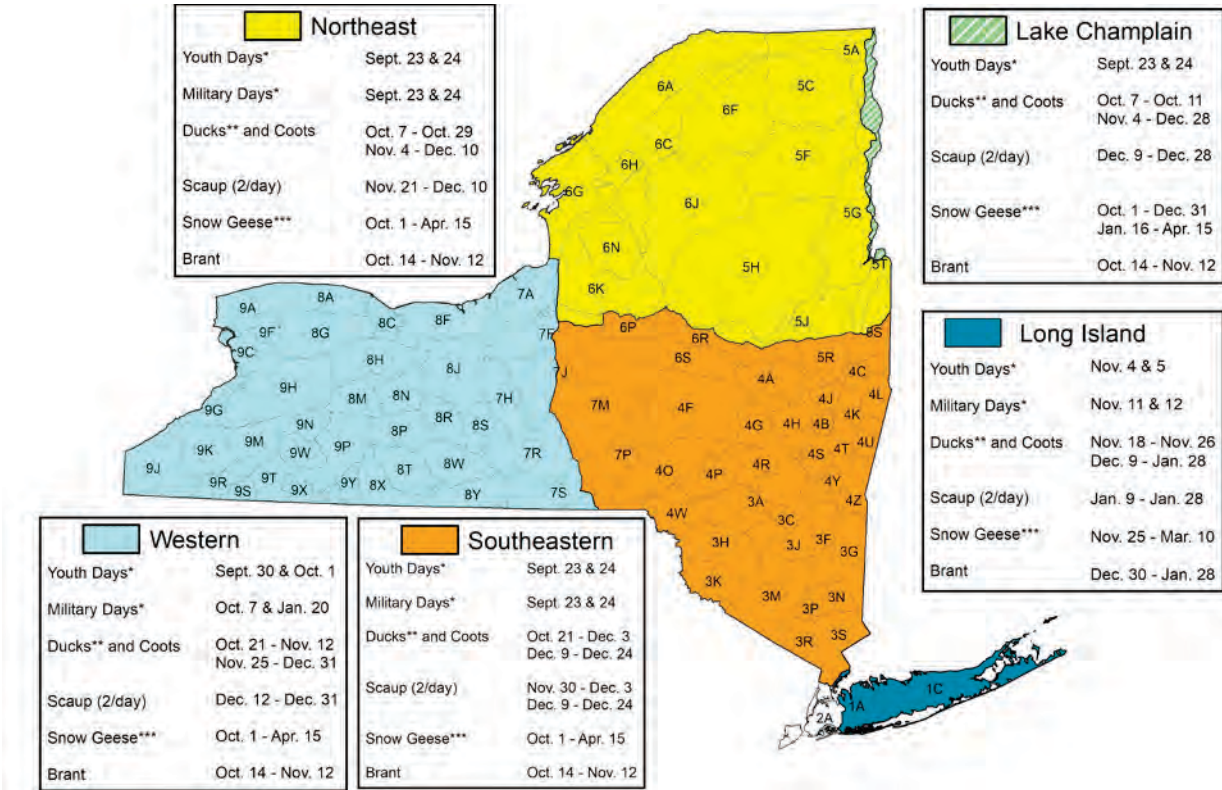

Bag Limits

The daily bag limit is the maximum number of birds of each species that any person may take or possess in the field during any one day. The possession limit is three times the daily bag limit for all migratory game birds except snow geese.

Species	Daily Limit	Possession Limit
Ducks ^a	6	18
Coot	15	45
Canada Geese ^b	See map	Three times the daily limit — see map page 54
Snow Geese ^b	25	No limit
Brant	1	3

- a The daily limit of 6 ducks includes all mergansers and sea ducks (scoters, eiders, and long-tailed ducks) and may include no harlequin ducks and no more than 4 mallards (2 of which may be hens), 3 wood ducks, 2 black ducks, 1 pintail, 1 scaup (2 scaup are allowed during the 20 days specified above for each zone), 2 redheads, 2 canvasback, or 4 sea ducks (including no more than 3 scoters, 3 long-tailed ducks, or 3 eiders and no more than 1 female eider). For all other duck species found in New York, the daily limit is no more than 6.
- b Cackling geese and white-fronted geese may be taken as part of the Canada goose daily and possession limits. Snow geese and Ross' geese may be taken as part of the snow goose limits.

- * Youth hunters, 12 to 15 years of age, possessing a junior hunting license and HIP registration, may hunt ducks, mergansers, Canada geese, brant, gallinules, and coot on two (2) special days in each zone. Daily bag limits for all species are the same as those allowed during the regular hunting season for all species. Youth hunters must be supervised by a licensed (including current HIP registration and duck stamp) adult hunter, and the mentor may not carry a firearm. This prohibition does not apply to other hunters in the party that are not mentoring the youth.
- ** Crippled sea ducks may be taken under power in the Special Sea Duck area, only. The Special Sea Duck Area is defined as the coastal waters of New York State and all waters of streams and rivers seaward from the first upstream bridge.
- *** Snow goose seasons include both the regular hunting season and the Conservation Order that runs from January 16 – April 15 in all zones (except Long Island).

Attention Boaters!

Before you launch your boat or leave a site, you are required to clean all visible plant and animal material from your boat, trailer, and associated equipment. Drain your boat's bilge, livewell, baitwell, and other water-holding compartments. For more information on aquatic invasive species, visit: www.dec.ny.gov/animals/50121.html.

Brianna's Law – New Boating Safety Law!

If you were born on or after:	You will need a boating safety certificate when operating a motorized vessel in:
January 1, 1993	2020
January 1, 1988	2022
January 1, 1983	2023
January 1, 1978	2024

All operators of motorized vessels, regardless of age, will need a boating safety certificate by January 1, 2025. For more information and to find courses: parks.ny.gov/recreation/boating/.

Military and Veteran Waterfowl Hunting Days

Northeast Zone — September 23 and 24

Southeast Zone — September 23 and 24

Western Zone — October 7 and January 20

Long Island Zone — November 11 and 12

Daily bag limit is the same as the regular season. There are no military/veteran hunting days in the Lake Champlain Zone.

Migratory Game Bird Hunting Seasons and Bag Limits

Woodcock, Crow, Snipe, Rail, and Gallinule Hunting Season Dates, Bag Limits, and Regulations for 2023–2024

Regulations	Woodcock	Crow	Snipe	Virginia & Sora Rails	Gallinules	Clapper & King Rails
Upstate New York ^{1,3}	Oct. 1 – Nov. 14	Sept. 1 – Mar. 31	Sept. 1 – Nov. 9	Sept. 1 – Nov. 9	Sept. 1 – Nov. 9	Closed
Long Island ^{2,3}	Oct. 1 – Nov. 14	Sept. 1 – Mar. 31	Closed	Closed	Closed	Closed
Bag Limit	3/day 9 in possession	None	8/day 24 in possession	8/day 24 in possession	8/day 24 in possession	n/a
Shooting Hours	Sunrise to Sunset	Sunrise to Sunset	1/2-Hr Before Sunrise to Sunset	1/2-Hr Before Sunrise to Sunset	1/2-Hr Before Sun- rise to Sunset	n/a
Non-Toxic Shot	NOT Required	NOT Required	Required	Required	Required	n/a
HIP Registration	Required	NOT Required	Required	Required	Required	n/a
Other	Fed Migratory Bird Stamp NOT Required	Hunting on Fri., Sat., Sun. & Mon. ONLY; Fed Migratory Bird Stamp NOT Required; Rifles and electronically amplified bird calls or sounds permitted	Fed Migratory Bird Stamp NOT Required	Fed Migratory Bird Stamp NOT Required	Fed Migratory Bird Stamp NOT Required	n/a

1 Upstate New York includes all of New York State north of the Bronx-Westchester County boundary

2 Long Island includes all of WMUs 1A and 1C (Nassau and Suffolk counties)

3 Hunting season closed in New York City for all species listed in table; New York City includes all of WMU 2A (Bronx, Kings, Queens, New York, and Richmond counties)

2023-2024 Canada Goose Seasons

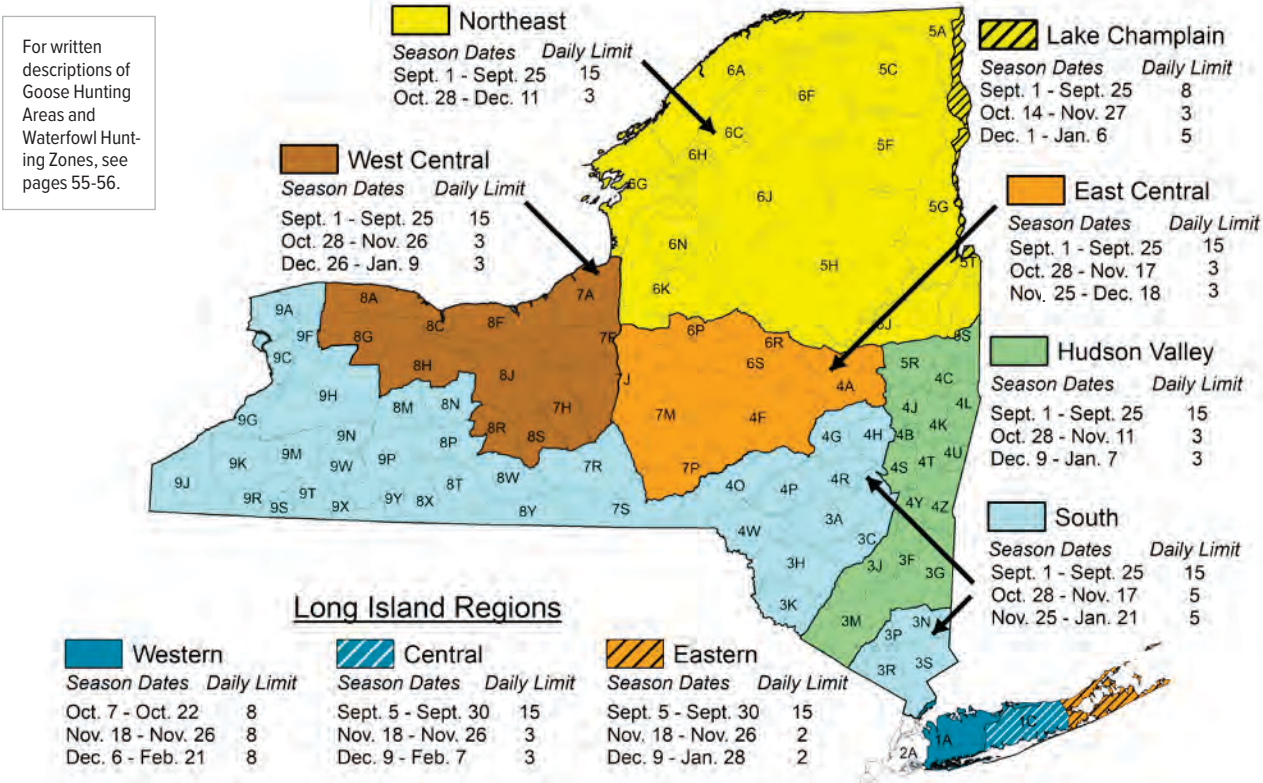

New York State Goose Hunting Areas

See road boundaries at www.dec.ny.gov/outdoor/28496.html

1. The Lake Champlain Goose Hunting Area is the same as the Lake Champlain Waterfowl Hunting Zone (see page 56).
2. The Northeast Goose Hunting Area is the same as the Northeastern Waterfowl Hunting Zone (see page 56).
3. The West Central Goose Hunting Area consists of the following WMUs: 7A, 7H, 8A, 8C, 8F, 8H, 8J, 8R, and 8S. The West Central Goose Hunting Area also includes: that part of WMU 6K lying west of a continuous line extending along the north shore of the Salmon River from US Route 11 to Interstate Route 81, then south along Route 81 to Route 49; those parts of WMUs 7F and 7J lying west of Route 81; and that part of WMU 8G lying north and east of a continuous line extending along the New York State Thruway from Crittenden-Murrays Corners Road (near the Erie-Genesee county line) to Exit 48 in Batavia, then south along Route 98 to Route 20.
4. The East Central Goose Hunting Area consists of the following WMUs: 4A, 4F, 6P, 6R, 6S, 7M, and 7P. The East Central Goose Hunting Area also includes those parts of WMUs 7F and 7J lying south of Route 31 and east of Route 81.
5. The Hudson Valley Goose Hunting Area consists of the following WMUs: 3F, 3J, 3M, 4B, 4C, 4J, 4K, 4L, 4S, 4T, 4U, 4Y, 4Z, 5R; that part of WMU 5S lying south of a continuous line extending east along Route 29 to Route 22, north along Route 22 to Washington County Route 153, then east along Route 153 to the New York–Vermont boundary; and that part of WMU 3G lying in Dutchess County.
6. The South Goose Hunting Area consists of the following WMUs: 3A, 3C, 3H, 3K, 3N, 3P, 3R, 4G, 4H, 4O, 4P, 4R, 4W, 7R, 7S, 8M, 8N, 8P, 8T, 8W, 8X, 8Y, 9A, 9C, 9F, 9G, 9H, 9J, 9K, 9M, 9N, 9P, 9R, 9S, 9T, 9W, 9X, and 9Y. The South Goose Hunting Area also includes: that part of WMU 8G lying south and west of a continuous line extending along the New York State Thruway from Crittenden-Murrays Corners Road (near the Erie-Genesee county line) to Exit 48 in Batavia, then south along State Route 98 to State Route 20; that part of WMU 3G lying in Putnam County; and that part of WMU 3S lying north of Route 1-95.
7. The Western Long Island Goose Hunting Area is that area of Westchester County and its tidal waters southeast of Interstate Route 95 and that area of Nassau and Suffolk counties lying west of a continuous line extending due south from the New York-Connecticut boundary to the northernmost end of Sound Road (just east of Wading River Marsh); then south on Sound Road to North Country Road; then west on North Country Road to Randall Road; then south on Randall Road to Route 25A, then west on Route 25A to Sunken Meadow Parkway; then south on Sunken Meadow Parkway to the Sagtikos State Parkway; then south on the Sagtikos Parkway to the Robert Moses State Parkway; then south on the Robert Moses Parkway to its southernmost end; then due south to international waters.
8. The Central Long Island Goose Hunting Area is that area of Suffolk County lying between the Western and Eastern Long Island Goose Hunting areas, as defined above and below.
9. The Eastern Long Island Goose Hunting Area is that area of Suffolk County lying east of a continuous line extending due south from the New York-Connecticut boundary to the northernmost end of Roanoke Avenue in the Town of Riverhead, south on Roanoke Avenue (which becomes County Route 73) to State Route 25, west on Route 25 to Peconic Avenue, south on Peconic Avenue to County Route (CR) 104 (Riverleigh Avenue), south on CR 104 to CR 31 (Old Riverhead Road), south on CR 31 to Oak Street, south on Oak Street to Potunk Lane, then west on Stevens Lane, then south on Jessup Avenue (in Westhampton Beach) to Dune Road (CR 89), then due south to international waters.

Waterfowl Hunting Zone Descriptions

Waterfowl Hunting Zones

Western Zone – That area west of a continuous line extending from Lake Ontario east along the north shore of the Salmon River to Interstate Route 81 and then south along Interstate Route 81 to the New York-Pennsylvania boundary.

Northeastern Zone – That area north of a continuous line extending from Lake Ontario east along the north shore of the Salmon River to Interstate Route 81, south along Interstate Route 81 to Route 31, east along Route 31 to Route 13, north along Route 13 to Route 49, east along Route 49 to Route 365, east along Route 365 to Route 28, east along Route 28 to Route 29, east along Route 29 to Route 22, north along Route 22 to Route 153, east along Route 153 to the New York-Vermont boundary, exclusive of the Lake Champlain Zone.

Lake Champlain Zone – That area east and north of a continuous line extending along Route 11 from the New York-Canada boundary south to Route 9B, south along Route 9B to Route 9, south along Route 9 to Route 22 south of Keeseville, south along Route 22 to the west shore of South Bay along and around the shoreline of South Bay to Route 22 on the east shore of South Bay, southeast along Route 22 to Route 4, northeast along Route 4 to the New York-Vermont boundary.



Jake, Bill S.'s hunting companion after a successful goose hunt

Southeastern Zone – That area east of Interstate Route 81 that is south of a continuous line extending from Interstate Route 81 east along Route 31 to Route 13, north along Route 13 to Route 49, east along Route 49 to Route 365, east along Route 365 to Route 28, east along Route 28 to Route 29, east along Route 29 to Route 22, north along Route 22 to Route 153, east along Route 153 to the New York-Vermont boundary, and northwest of Interstate Route 95 in Westchester County.

Long Island Zone – That area consisting of Nassau and Suffolk counties and their tidal waters, and that area of Westchester County and its tidal waters southeast of Interstate Route 95. (See map page 49).

Special Sea Duck Area – All coastal waters and all waters of rivers and streams in New York State seaward from the first upstream bridge.

Choosing Duck Season Dates

New York has five waterfowl zones, which allow DEC flexibility to select duck season dates that match hunter values and duck migration in each zone. In 2019, DEC implemented a new process for selecting duck seasons that pairs input from a large portion of New York duck hunters with data of duck movements and in-season patterns of duck abundance. Duck season frameworks are set on a 5-year cycle. The 2023–2024 duck season is the final year of the cycle.

During the winter of 2023, DEC surveyed all duck hunters that registered for HIP via an email survey to re-assess what factors are the most important to duck hunters in each zone. DEC added questions to understand the relative importance of icing (freezing of smaller ponds, lakes, and streams) in relation to hunter satisfaction with season dates. Icing concentrates duck activity on larger lakes and rivers with open water and may be viewed positively or negatively by hunters depending on the types of equipment (i.e. boat) duck hunters use or the habitats in which they typically pursue ducks. The survey also specifically asked duck hunters about which species are most important to them.

This spring, DEC met with the Waterfowl Hunter Task Force in each zone to develop a list of possible season date options that might meet the range of varying hunter objectives. These season options will be evaluated relative to data trends (abundance, migration timing, ice/temperature) and important hunter values identified in the survey to determine which season date option best aligns with what hunters value. The results of the process will be used to set the duck season dates for each zone from 2024–2029.





John Mack

General Regulations

To hunt furbearers, you must possess a resident or non-resident hunting license. A trapping license does not allow you to hunt furbearers. Furbearers may be hunted with a bow, crossbow, or firearm as described below.

- You may hunt red and gray fox, coyote, bobcat, raccoon, skunk, weasel, and opossum anywhere in the state with an open season.
- If you take a bobcat, it must be tagged and sealed.
- You may use a call, including an electronic call.
- Mink may only be hunted in the Southern Zone with a firearm not larger than .22 caliber during their open trapping season. Mink may not be hunted with a firearm in the Northern Zone.
- Muskrat may only be hunted on Lake Champlain during the open trapping season with a firearm not larger than .22 caliber.
- You may not hunt from any motor vehicle, including an ATV or snowmobile.
- Except as noted above, you may hunt furbearers using any handgun, shotgun, muzzleloading rifle, bow, crossbow, or air gun.

Bobcat Hunting

Hunting Hours: After sunrise on opening day; and at any hour, day or night, for the rest of the hunting season.

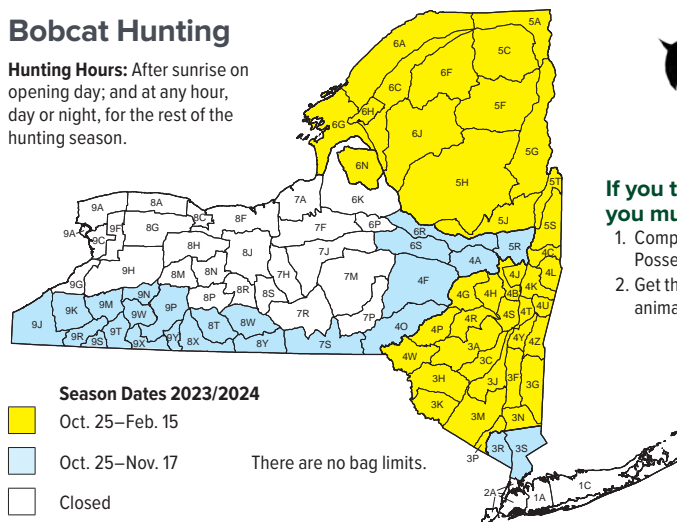

If you take a bobcat, you must:

1. Complete a Furbearer Possession Tag **AND**
2. Get the pelt or unskinned animal sealed.

Weasel, Opossum, Skunk, Raccoon, and Fox Hunting

Long Island: Nov. 1–Feb. 25
All other areas of New York: Oct. 25–Feb. 15

There are no bag limits for these species. **Hunting Hours:** After sunrise on opening day; and at any hour, day or night, for the rest of the hunting season.



Coyote Hunting

Statewide except Long Island and New York City: Oct. 1–Mar. 31

There are no bag limits for coyotes. They may be hunted during the day or night.



Possession and Use of Rifles for Hunting Furbearers

1. Is **any deer season open** in the location you wish to hunt (including archery, muzzleloading, regular, late, and Focus Area)? (pg. 25)
 - a. If **NO**, you may use any caliber rimfire or centerfire rifle for hunting furbearers.
 - b. If **YES**, can deer be hunted with rifles in that location during the regular season? (pg. 24)
 - i. If **YES**, you may use any caliber rimfire or centerfire rifle for hunting furbearers during any open deer season.
 - ii. If **NO**, you may only possess afield rimfire rifles .22-caliber or smaller, or centerfire rifles **LESS THAN** .22 caliber (.204, .17, etc.) during any open deer season. Once all deer seasons are closed, the restriction ends, except:
2. You may **NEVER** possess a rifle afield in Westchester, Nassau, and Suffolk counties.
3. In the Northern Zone, it is illegal to carry a rifle larger than .22 caliber rimfire (or .22-caliber or larger centerfire rifles) at any time if accompanied by a dog, except when coyote hunting.

Hunting Furbearers at Night

- Spotlights, night vision, thermal and laser devices are permitted for furbearer hunting. They may be attached to the firearm. All laws pertaining to the use of a spotlight apply.
- Hunters should consult with local government officials for any laws that may prohibit the discharge of firearms at night.

Trappers and hunters who assist with furbearer management activities are eligible to receive a special patch!

You can receive a patch if you turn in an incidentally trapped animal; turn in a road-killed fisher, marten, bobcat, otter, or weasel; report a violation that results in a conviction; provide data or assist with a research project; or promote furbearer hunting or trapping. Carcasses are used for biological data, training, education, and outreach. Contact your regional wildlife office for more information.



Distinguishing Wolves from Coyotes

Wolves

Wolves are very rare in New York, with only three confirmed in the past 25 years, including one harvested by a coyote hunter in 2021. Wolves are protected in NY as an endangered species. They can be distinguished from coyotes by their larger size, typically weighing between 70–100 pounds and measuring over 2 feet tall at the shoulder. Wolves have proportionally small, rounded ears and a shorter, blockier snout than coyotes. Their feet are larger, with tracks measuring about 5 inches long by 4 inches wide.

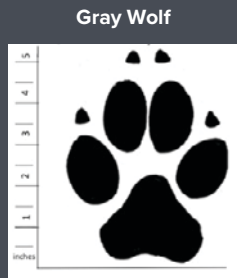

Coyotes

Eastern coyotes are common in New York, found throughout the State. There are regulated hunting and trapping seasons for coyotes in NY. Eastern coyotes have a mix of coyote, wolf, and dog ancestry and are larger in size (about 40 pounds, on average) than coyotes west of the Mississippi. They are smaller than wolves, rarely weighing more than 50 pounds and standing less than 2 feet tall at the shoulder. Coyotes have long, narrow snouts that end in a point. Their ears are large relative to the head and are pointed in shape. Coyotes have smaller feet than wolves; their tracks typically measure 3 inches long by 2 inches wide. If you have a canine in a trap that is over 4.5 ft in length and is over 50 pounds, contact DEC law enforcement (1-844-332-3267) before dispatching the animal.

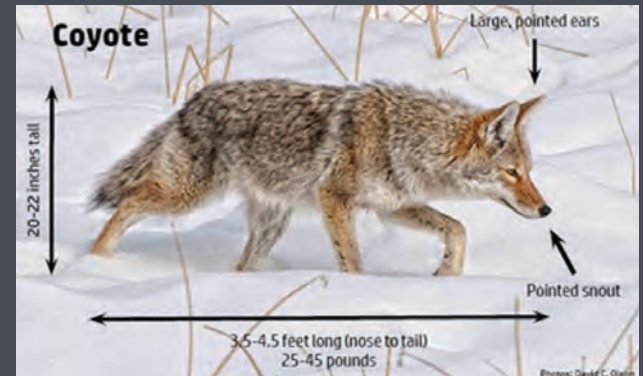

Definition of Trapping

To trap means to take, kill, or capture wildlife with traps, deadfalls, and other devices commonly used to take wildlife, including the shooting or killing of lawfully trapped animals. It also includes all related activities such as placing, setting, staking, or checking traps or assisting another person with these activities. You do not need a hunting license to shoot a trapped animal.

Other Definitions

- **Public Highway:** The traveled portion of a public highway. Culverts, drainage ditches, and the area under bridges are not considered the traveled portion of a public highway.
- **Carcass:** The body or parts thereof, meat, organs or viscera of an animal, including fish. Feathers (including feathers with attached skin or entire bird wings), hair (with or without skin or hide), and bones that include no attached meat, organs or viscera, are excluded from this definition.
- **Suspension:** This term applies to animals fully suspended in the air by means of the trap anchoring system (typically a chain, cable, or wire). It does not apply to traps set in water or to traps that are directly and firmly attached to an elevated structure, such as a tree.
- **Restraining trap:** A device used to capture and restrain a mammal. These traps include leg-gripping traps (foothold traps), foot encapsulating traps, and cage or box traps.
- **Foot encapsulating trap:** A trap with the following mechanical attributes: The triggering and restraining mechanisms are enclosed within a housing; the triggering and restraining mechanisms are only accessible through a single opening when set; the opening does not exceed 2 inches in diameter; and the trap has a swivel-mounted anchoring system.
- **Cage or box trap:** A type of restraining trap that fully encloses a captured animal within wood, wire, plastic, or metal.

Legal Traps

- You must put your name and address or your DEC customer identification number (see your hunting or trapping license) on all your traps.
- Foothold traps larger than 4" set on land must have a pan tension device and be covered when set.
- Teeth are not allowed on foothold traps.
- On land, foothold traps must be 5¾" or smaller (inside jaw spread). For information on how to correctly measure traps, see page 61.
- During beaver or otter season, foothold traps up to 7¼" are allowed if set under water.

Reminders on Pelt Sealing

All bobcat, fisher, otter, and marten need to be sealed within 10 days after the close of the season in the WMU where the fur was taken. Some things to keep in mind to make the pelt sealing process go smoothly:

- Contact your local wildlife office to make pelt sealing arrangements prior to showing up.
- When freezing an unsealed pelt, make sure that the face is on the outside and easily accessible.
- If having an unsealed animal mounted, thaw the carcass enough so that a seal can be inserted through the eye or foot. Inserting a stick or similar object through a pre-made hole makes the sealing process much easier. If this is not done, it may be impossible to seal the animal at that time.

- When the beaver or otter season is closed, foothold traps set in water may not be larger than 5¾".
- A foothold trap larger than 7¼" is never legal to use.
- Body-gripping traps more than 7½" may never be used on land.
- Body-gripping traps more than 7½" may only be used in water during an open beaver or otter season.
- Snares may not be used for trapping.
- Box or cage traps are legal for all species.
- You may not use a cage trap that is designed to take more than one muskrat at a setting.

Land trapping

- You may not set a trap in such a manner that it causes a captured animal to be fully suspended in the air.
- In the Northern Zone, body-gripping traps set on land may not be set with bait or lure when the fisher and /or marten seasons are closed.

Water trapping

- You may set a trap in a permanent body of water only when the mink, muskrat, otter, or beaver season is open.
- You may not disturb a muskrat house or den.
- You may not set a trap on or within 5 feet of a muskrat house.

Trapping Methods

Checking traps

- In the Southern Zone: You must check traps once in each 24-hour period.
- In the Northern Zone, follow these rules:
 - » **WMU 5C, 5F, 5G, 5H, 5J, 6F, 6J, and 6N:** Visit once in each 48-hour period
 - » **WMU 5A, 6A, 6C, 6G, 6H, and 6K:**
 - **Traps set in water during the open season for beaver, otter, mink and muskrat:** Visit once in each 48-hour period
 - **Body-gripping traps set on land:** Visit once in each 48-hour period
 - **Restraining traps:** Visit once in each 24-hour period

Use of carcasses as bait

Any carcass, as defined above, used as bait and placed or used in conjunction with a foothold trap shall be completely covered at the time the trap is set or visited. Coverings shall include but not be limited to brush, branches, leaves, soil, snow, water, or enclosures constructed of wood, metal, wire, plastic, or natural materials, and must completely cover the carcass so that it is not visible from directly above.

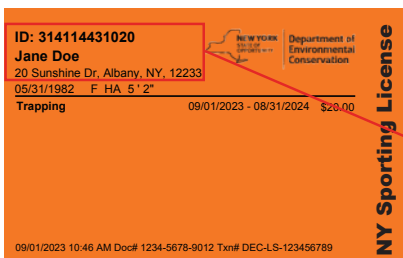

Place your name and address or Customer ID # on all your traps.



Furbearer Trapping

Land or water trapping

- You may use any legal method to kill a trapped animal. You do not need a hunting license to use a firearm to kill a legally trapped animal.
- You may not set or stake a trap prior to 7:00 AM on opening day.
- You are not allowed to set a trap within 100 feet of a house, school, playground, or church unless you have permission from the owner of the land where the trap is set.
- You may not set a trap on a public road. You are allowed to set a trap in a culvert or ditch unless the property is posted or the landowner does not allow trapping.

Trapping near beaver dams and lodges

- You may not disturb a beaver lodge or beaver dam.
- You may not set a trap on or within 15 feet of a beaver dam, den or house, measured at ice or water level, except under the following conditions:
 - » during an open otter season, traps of any legal size may be set on or within 15 feet of a beaver dam, but not on or within 15 feet of a beaver den or house;
 - » during an open or closed otter season, any of the following traps may be set on or within 15 feet of a beaver dam, den, or house:
 - body-gripping trap that measures less than 5.5 inches;
 - foot-encapsulating trap
 - foothold trap that measures 4¾ inches or less;
 - cage or box trap.

By limiting the trap sizes that are usable on beaver dams, this regulation provides opportunities for trappers while minimizing the accidental capture of otter.

Pelt Sealing

Otter, bobcat, fisher, and marten must have a plastic seal attached to the pelt or unskinned animal before:

- It is sold or ownership is transferred to another person, or
- It is mounted or tanned, or
- It leaves New York State, or
- Ten days have passed since the close of the season where the fur was taken

The plastic pelt seals can be removed when the pelt is processed for taxidermy, tanning, or manufacturing.

How to get your pelts sealed: a two-step process

- **Step 1:** Fill out your furbearer possession tag.
 - » A possession tag must be filled out for each animal you take.
 - » Possession tags must be filled out immediately after you reach your motor vehicle, camp, or home, whichever comes first.
 - » Possession tags must stay with the animal or pelt at all times, but they do not need to be attached to the pelt.

- » Furbearer possession tags can be obtained from your Regional Wildlife Office (see page 6) or at www.dec.ny.gov/outdoor/9209.html#Seals.
- **Step 2:** Get your pelt sealed (see below).
 - » A completed furbearer possession tag must be submitted to obtain a plastic pelt seal.
 - » You can give your pelts to another person (other than a taxidermist) so he or she can get the pelts sealed or get them skinned. You must give that person your trapping license or a copy of your license and your completed possession tags while he or she has your pelts.
 - » Only authorized DEC representatives can attach the plastic pelt seals to otter, bobcat, fisher, or marten.
 - » Call a Regional Wildlife Office (see page 6) to make arrangements to get your otter, bobcat, fisher, or marten sealed. Seals for these species cannot be sent through the mail.
 - » Special arrangements for no-contact sealing of pelts related to COVID-19 concerns can be made by contacting a regional wildlife office.
 - » If the plastic pelt seal is broken or damaged, contact your Regional Wildlife Office for a replacement seal.

Buying and Selling Fur

- Species requiring a pelt seal cannot be bought or sold or given to another person unless they have the plastic pelt seal attached to the animal. All other species may be bought, sold, and transported without restriction.
- Furbearers may be bought or sold either skinned or unskinned.
- People who buy fur do not need a fur buyer's license in New York.

Rights of Trappers

- No one may disturb a trap lawfully set by another person.
- No one may remove a lawfully trapped animal from another person's trap.
- No one may harass a trapper while he or she is trapping.

License Responsibilities

- A license is not transferable and can be used only by the person to whom it was issued.
- A license to trap does not give the holder any right to go on private property without permission of the landowner.
- It is illegal to refuse to show your license on demand to a law enforcement officer or the owner, lessee, or person in control of the lands (or their designees) while on their property.

Trapping License Exceptions

- All residents must have a valid trapping license in their possession except:
- Resident owners primarily engaged in farming, lessees, and members of their immediate families do not need a trapping license when

trapping on farm lands they are occupying and cultivating, for bobcat, coyote, fox, mink, muskrat, raccoon, opossum, weasel, skunk, and unprotected wildlife that may be lawfully taken by trapping. (**Note: beaver, otter, fisher and marten are not included.**)

- Native Americans living on a reservation do not need a trapping license while trapping on reservation lands.

Incidental and Accidental Captures of Trapped Animals

There are no provisions in the Environmental Conservation Law allowing trappers to possess animals that are taken outside of the open trapping season.

You must attempt to release any animals that are accidentally captured when the season is closed or if the area is not open for trapping that species.

If the animal is injured to the extent you believe it will not survive, humanely dispatch it. If you are not sure, contact a DEC Regional Wildlife Office or ECO for assistance.

When you find an unintentionally captured animal dead in the trap, or when you must dispatch an unintentionally captured animal due to a serious injury, you may remove it and lay it in the vicinity of the trap. There are no legal provisions for you to keep it, and you may not possess it even to take it back to your vehicle without permission from DEC.

DEC seeks information on all accidentally taken bobcat, otter, fisher, and marten, as well as other species of unusual nature. If the animal is dead, a DEC biologist will want to collect the carcass. Using the location and carcass data, biologists will be able to track the status of these species and study the age and reproductive data from the individual. The pelts from these carcasses will also be utilized in our trapper education classes.

Remember, you must contact the Regional Wildlife Office or an ECO as soon as possible to report the catch. You will receive instructions on what to do and information to provide.

Possession of Road-Killed Furbearers

If the trapping or hunting season is open for the species in a WMU, you may keep a dead furbearer found on roads within that WMU. The requirements for possessing road-killed furbearers are the same as for trapping and hunting. For example, if you find a road-killed bobcat in an area with an open bobcat season, you can possess it if you have a hunting or trapping license, but you must fill out a furbearer possession tag and have the pelt sealed.

How to Measure a Trap

How to measure a body-gripping trap:

Measure the inside distance between the outer frames of the trap. The addition of one or more bars to the inside of the frame does not change the way these traps are measured. The measurement is still the MAXIMUM distance as shown in the top picture.

How to measure a foothold trap:

Measure the inside distance between the jaws excluding the gripping surface as shown. If the jaws have inside laminations, the measurement is the inside distance between the laminations. If the trap has double jaws, measure the inside distance between the outer jaws.

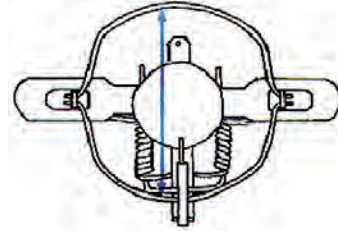
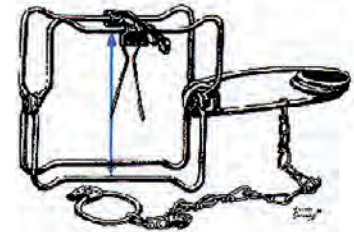

5¾" or less on land, 7¼" or less under water

Trigger Regulations for Beaver Trappers

This regulation applies if you:

- Trap in a WMU in the Southern Zone during a closed otter season; and
- Use a body-gripping trap larger than 8½ inches (these are "330" size traps).

1. **Body-gripping trap with off-set parallel trigger:**
2. **Example of non-legal vs. legal trigger brackets:**

Non-legal: V-notch, four-way trigger



Two-way tension adjustable (legal)



Two-way non-tension adjustable (legal)



Four-way trigger (not legal)

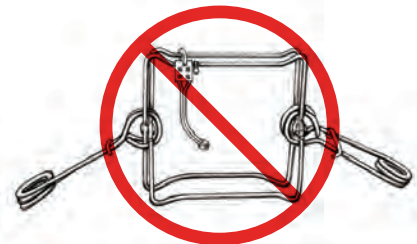
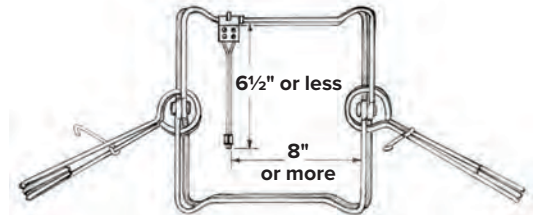

Legal: square-notch, two-way trigger

3. **Examples of acceptable parallel triggers:**

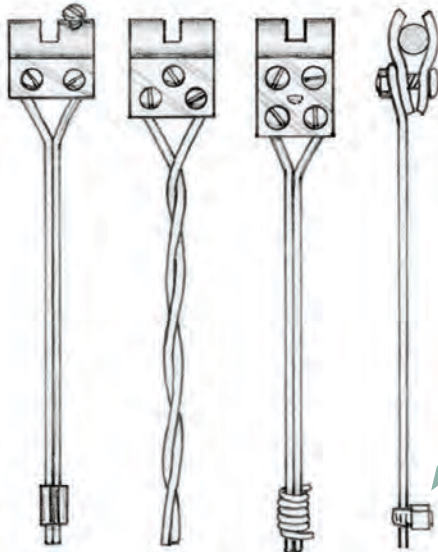

4. **Tension-adjustable triggers and trigger stops are no longer required.**

The trigger must be 6½" or less.

Recommended tension: 8 to 12 oz.

Trigger wires must be joined together.

NOTE:

1. You can bait these traps in any manner. However, the trap must have all of the features noted above.
2. There is no exception for traps set under ice; traps set under ice, whether baited or not, must have all of the design features noted above.
3. There is no tension requirement. However, DEC research showed that 8 to 12 oz. of tension works best for protecting otter and catching beaver.

Furbearer Trapping

Regulations for Body-Gripping Traps Set on Land

Body-gripping traps set on land shall not be within 100 feet of a public trail except on Wildlife Management Areas.

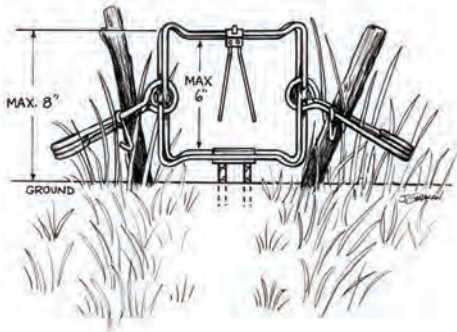

A body-gripping trap measuring less than 5½ inches may be set in any manner **with or without the use of bait**. Body-gripping traps measuring 5½ inches to 6 inches, set without the use of bait, must be set so that no part of the trap is 8 inches or more above the ground. Body-gripping traps measuring more than 6 inches to 7 1/2 inches may never be set in this manner.

NOTE: During a closed season for fisher and/or marten in the Northern Zone, body-gripping traps set on land may not be set with bait or lure.

Body-gripping traps 5½ inches to 7½ inches set **with the use of bait, lure, or other attractants** may only be used as follows:

- ✓ Four or more feet off the ground

OR

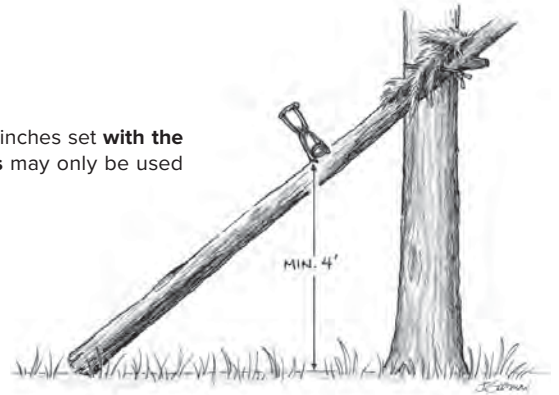

- ✓ In a container of the following design:

- Trap recessed minimum of 18 inches
- Opening height and width 10 inches or less

OR

- ✓ In a container of the following design:

- Only one entrance, facing the ground
- Container set so entrance is no more than 6 inches from ground
- Trap recessed minimum of 4 inches

OR

- ✓ In a container of the following design:

- Opening height 6 inches or less
- Eight-inch minimum spring notches
- Trap recessed minimum of 4 inches

You may also build an enclosure of natural materials (e.g., logs or rocks)

- Opening height 6 inches or less
- Trap recessed minimum of 8 inches

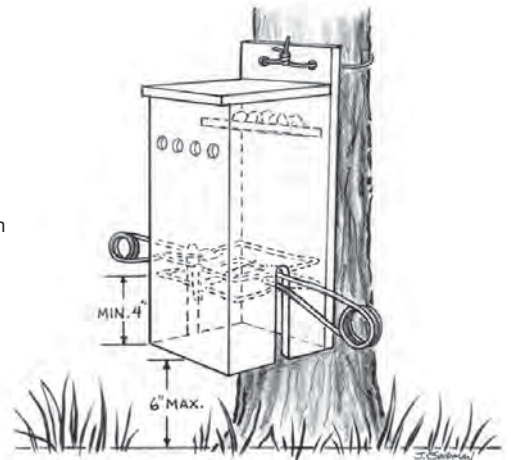
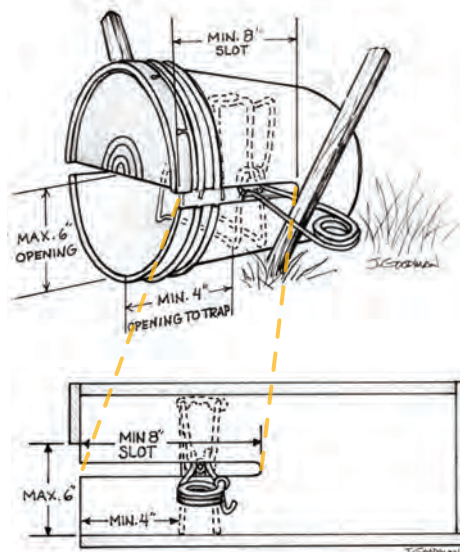
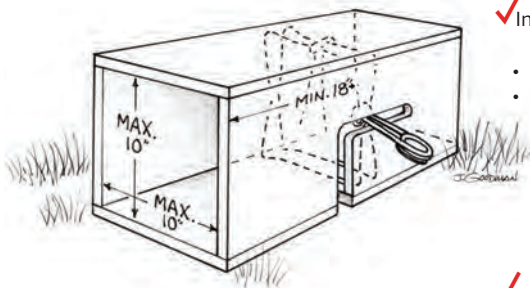

Fisher & Marten Trapping

To trap marten, you also need a free permit from a Regional Wildlife Office. A special permit is no longer needed to trap fisher.

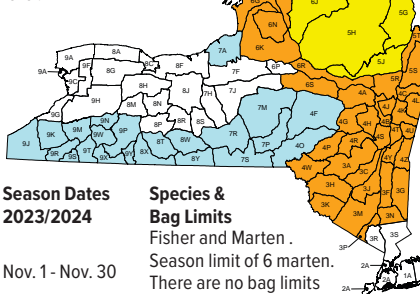

If you take a fisher or marten you must:

- Complete a furbearer possession tag, AND
- Get the pelt or unskinned animal sealed.

Season Dates 2023/2024

Species & Bag Limits	Fisher and Marten.
Nov. 1 - Nov. 30	Season limit of 6 marten. There are no bag limits for fisher.
Oct. 25 - Oct. 30	Fisher only. There are no bag limits.
Oct. 25 - Dec. 10	Fisher only. There are no bag limits.
Closed	Fisher and Marten



Raccoon, Red Fox, Gray Fox, Skunk, Coyote, Opossum & Weasel Trapping

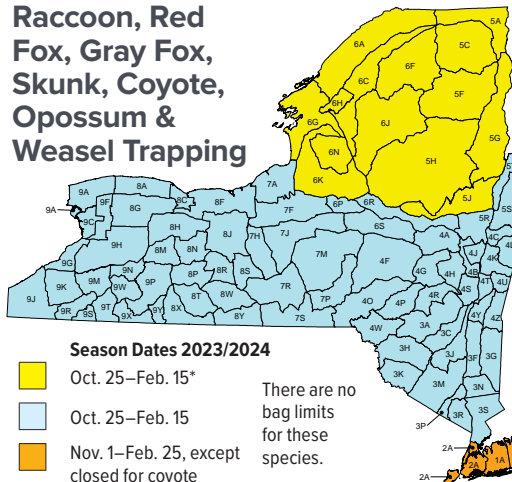

Season Dates 2023/2024

Oct. 25 - Feb. 15*	There are no bag limits for these species.
Oct. 25 - Feb. 15	
Nov. 1 - Feb. 25, except closed for coyote	



* In the Northern Zone (see page 24) body-gripping traps set on land may not be set with bait or lure if the fisher and marten season is closed.

Mink & Muskrat Trapping

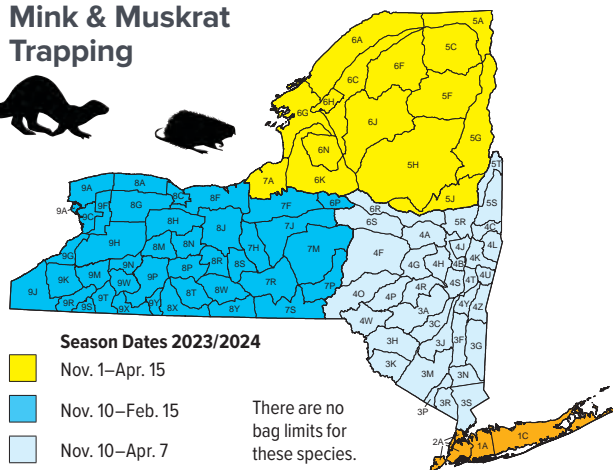

Season Dates 2023/2024

Nov. 1 - Apr. 15	There are no bag limits for these species.
Nov. 10 - Feb. 15	
Nov. 10 - Apr. 7	
Dec. 15 - Feb. 25	

Bobcat Trapping

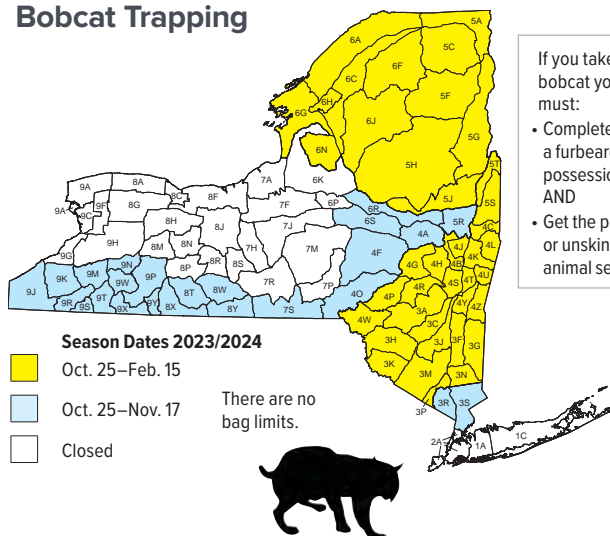

Season Dates 2023/2024

Oct. 25 - Feb. 15	There are no bag limits.
Oct. 25 - Nov. 17	
Closed	



If you take a bobcat you must:

- Complete a furbearer possession tag, AND
- Get the pelt or unskinned animal sealed.

Beaver Trapping

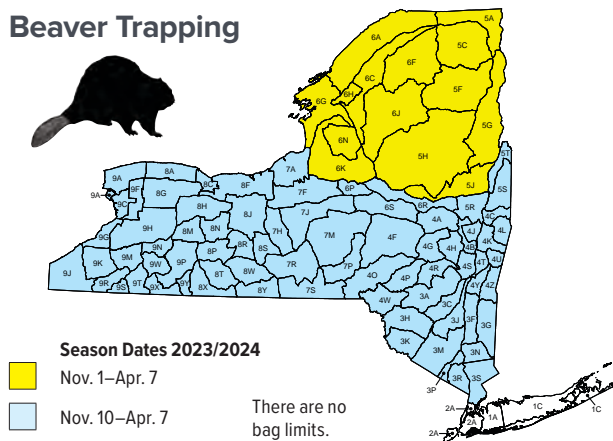

Season Dates 2023/2024

Nov. 1 - Apr. 7	There are no bag limits.
Nov. 10 - Apr. 7	
Closed	

River Otter Trapping

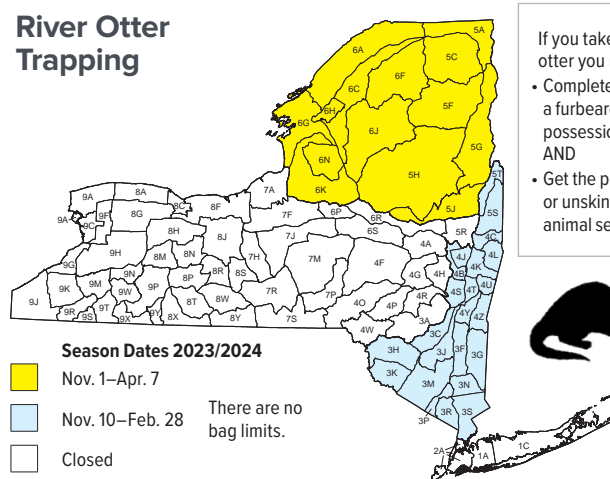

Season Dates 2023/2024

Nov. 1 - Apr. 7	There are no bag limits.
Nov. 10 - Feb. 28	
Closed	

If you take an otter you must:

- Complete a furbearer possession tag, AND
- Get the pelt or unskinned animal sealed.



Furbearer Trapping

Game Recipe: BEAVER-CUE

Prep time: 30 minutes active, 24-36 hours total

Yields 4-6 sandwiches

Ingredients:

- 2 beaver front or hind quarters
- 8 cups Carolina brine (recipe below)
- 1 quart light to medium stock (chicken, goose, duck, or beaver)
- 1 cup apple cider vinegar
- 1 onion, roughly chopped
- Salt to taste

Carolina Brine:

- ½ cup brown sugar
- ½ cup salt
- 8 cups water
- 1 tbsp mustard seeds
- 1 tsp red pepper flake
- 2 bay leaves

Method:

Combine all brine ingredients and bring to a simmer, then allow to cool completely before submerging the meat in the brine. Allow to sit, refrigerated, for 24-36 hours. Remove from brine.

If you have a smoker, go ahead and smoke the meat for 1-2 hours over low heat (under 200 degrees).

Place the meat in a crockpot or Dutch oven and add stock, onion salt and vinegar. Cook on low heat for 6-8 hours until the meat is easily pulled from bone with a fork. Allow it to cool in the cooking liquid until ready to serve. Remove from the liquid, shred from bone, and serve with your favorite BBQ sandwich fixin's.

Recipe provided by Wade Truong and Rachel Owen of Elevated Wild. For more delicious recipes, visit their website (elevatedwild.com) or Instagram ([elevatedwild](https://www.instagram.com/elevatedwild)).



Permit Requirements for Marten

A free special permit is still required to trap marten in New York. To receive a permit, contact the DEC Region 5 Wildlife Office in Warrensburg at 518-623-1240. You must provide the following information:

- Name
- Mailing address
- DEC ID # (from your trapping license or backtag)
- Phone number or email address.

You can also apply by email to: wildlife@dec.ny.gov, type "Marten Permit" in the subject line. Please be sure to include the information listed above.



Report Your Furbearer Sightings!

DEC wants to learn more about the occurrence of various furbearers throughout New York such as bobcat, otter, fisher, weasel, and snowshoe hare. Your observations help biologists understand the distribution and abundance of these elusive or inconspicuous mammals.

You can report your observations online, and you can even include photos!

Go to www.dec.ny.gov/animals/30770.html or email us at wildlife@dec.ny.gov

Thanks for your help!

Adopt Trapping Best Management Practices (BMPs)

- Learn practical traps and techniques that improve efficiency, selectivity, and the welfare of trapped animals
- Find out about specifications for traps that meet BMP criteria for each species
- Instill public confidence in and maintain public support for trapping

Visit www.dec.ny.gov and search "Trapping BMPs"

TRAPPING IS OUR HISTORY.
WILL TRAPPING BE IN OUR FUTURE?



BECOME A TRAPPER
EDUCATION INSTRUCTOR!

APPLY TODAY!

- 1-888-HUNT-ED2 (1-888-486-8332)
- www.dec.ny.gov/outdoor/9189.html

New York State & Environmental Conservation Police

Q: Can I use a carcass tag from a friend or family to put on a deer, bear, or turkey that I shot?

A: No — it is unlawful to possess or use tags of another person, except properly consigned Deer Management Permits (DMPs) or landowner DMAPs. See DMP tag transfer instructions on page 29.

Q: I'm using an app that shows land owned by NY State — can I hunt on that land?

A: State lands are owned by DEC, DOT, SUNY, NYS Parks, Thruway, and others. It's your responsibility to check the rules for each property, as even some DEC lands are off-limits to hunting. You can always contact your local ECO to determine legality (pages 68–69).

Q: What documentation must I carry when hunting?

A: You must carry your hunting license, plus carcass tags (deer, bear, turkey), any special permits (e.g., turkey permit), and a duck stamp with HIP# (if hunting migratory game birds), plus a back tag (where required). "Hunting license" means the printed license listing privileges or a lifetime license card or NY driver's license with an "Adventure" hunting icon. You may also use your HuntFishNY app for proof of a hunting license, provided you still have your back tag (where required) and carcass tag(s). Crossbow hunters need to carry their hunter education certificate or the crossbow certificate. Special hunts or hunt areas may require additional paperwork.

Q: Why can NY stores sell deer bait and salt blocks when it is illegal to use them for hunting in NY?

A: The law and regulation do not prohibit sale, but they prohibit the use of bait to aid in hunting and feeding deer (and bear) at all times. If the material is placed where the animal may ingest it, it is likely to be considered baiting or feeding.

Q: Are deer urine scents legal in NY?

A: Yes, but DEC strongly urges hunters not to use natural deer urine products to protect NY deer from Chronic Wasting Disease. Hunters who want to use deer attractant scents should only use synthetic products.

Q: Why aren't food plots considered feeding or baiting?

A: DEC regulations exempt wildlife food plots from feeding and baiting prohibitions as "areas established by standard agricultural production practices." Wildlife food plots do not concentrate deer in the same way as supplemental feed sites and do not entail the same risk of disease spread, behavioral changes, or localized ecological damage.

Q: Can I hunt small game with a rifle in counties where deer hunting with a rifle is prohibited?

A: Yes, but if any deer season is open, you cannot use a rifle larger than .22 caliber. You may not possess rifles afield on Long Island or in Westchester county.

Q: If the trapping season is open, can I hunt for that species?

A: It depends on the season and species. Some furbearers may only be trapped, while some can also be hunted, but with different seasons. Coyote is a good example of a species that can be hunted and trapped, but season dates for hunting and trapping this species are different, so be sure to check the guide before going afield.

Q: Are there exceptions to the 500' rule for discharge of a firearm?

A: You may discharge a firearm within 500' of an occupied dwelling or structure only under the following situations: 1) you own it, lease it, are an immediate member of the family, an employee, or have the owner's consent; 2) if you are hunting waterfowl over open water, provided there are no dwellings, public structures, or people within 500' of the direction you are shooting.

Q: After reporting my deer, transporting, and cutting it up, what do I do with the carcass tag?

A: The tag stays with the carcass and is not needed after the deer is prepared for consumption. DEC strongly encourages all hunters to dispose of your carcass waste in a landfill as a best practice for minimizing disease risks.

Q: I shot an animal and it died on a neighboring property. Can I legally go retrieve it?

A: You must obtain permission from the property owner to retrieve the animal.

Q: I own a camp and property in New York. Can I purchase a resident hunting license?

A: Residency is a fixed, permanent, and principal home to which a person always intends to return. Simply owning land or paying taxes does not make one eligible for resident license fees. More information on residency is found on page 10.

Q: Can our hunting party share Deer Management Permits (DMPs) on a deer drive?

A: Only the person possessing the DMP may take an antlerless deer. DMPs may be consigned from one hunter to another, but this needs to happen before the deer is harvested. See the DMP consentment rules for more info.

Q: Can I target shoot on DEC lands?

A: Yes, on some DEC lands. Many DEC state lands, including State Forests and Wildlife Management Areas (WMAs) have specific rules prohibiting target shooting in some or all areas — call ahead. If a portion of a DEC property is posted as being open to target shooting, you may not damage live trees and must remove all litter.

Q: Can junior hunters (12–15-year-old) hunt deer with a firearm?

A: 12- and 13-year-olds can hunt deer with a firearm only in counties that have opted into this opportunity. 14- and 15-year-olds can hunt deer with a firearm in any county open to deer hunting with a firearm. All junior hunters must be supervised by a licensed adult hunter. NYS law requires that the junior hunter and their mentor wear blaze orange/pink and remain on the ground.

Q: Can I carry a handgun while bowhunting deer/bear during the special bowhunting seasons?

A: No, you may not possess a firearm of any type while bowhunting during those seasons. Possession of a handgun in NY requires a NY Pistol Permit. NY does not recognize any permits from other states.

Q: May I transport an entire deer carcass into NY from another state?

A: No. DEC prohibits importation of whole deer, elk, moose, or caribou carcasses from anywhere outside of New York State to protect our deer and moose from Chronic Wasting Disease. See page 18 for details.

Q: When do tree stands have to be removed from state-managed lands?

A: On DEC-managed lands, tree stands (including scaffolds, raised platforms, ladders, steps, and other devices to assist in climbing) labeled with a name and address or DEC ID number may be left overnight but must be removed at the end of the hunting season. Tree stands (including ladders and steps) may not injure the tree. A permanently placed raised platform or tree stand may be used for hunting on private land with the permission of the landowner.

Q: When do duck blinds have to be removed?

A: Hunting blinds placed in navigable waters must be labeled with the owner's name and address then removed from navigable waters no later than March 15 each year.

Q: When waterfowl hunting, how far offshore are you allowed to anchor down? Is this considered trespassing?

A: Where a waterfowl hunter can anchor varies depending on the location. Ultimately, it is the hunter's responsibility to ensure they can legally anchor and hunt where they are discharging their firearm. In most non-tidal areas, the property boundary is the mean low water mark and hunters can legally anchor below this mark. However, the hunter should confirm the under water lands are within the public domain. Most counties now have publicly accessible property boundary maps online. In tidal areas, the public domain typically extends to the mean high-water mark.

Q: What animals require pelt seals in New York? How do I get them sealed?

A: Fisher, Marten, Otter (trapped), Bobcat (hunted or trapped) require a pelt seal. To have a pelt sealed, bring your game to your local DEC office, or contact an ECO in your area.

Q: What are the legal specifications for a crossbow?

A: They must have a minimum overall length from the butt of the stock to the front of the limbs of 24 inches, a minimum limb width of 17 inches, and be able to launch a minimum 14-inch arrow/bolt (not including arrowhead). The draw weight must be 100–200 pounds. Crossbow specifications, like all aspects of crossbow use for hunting, are established in law by the NYS Legislature and Governor.

Q: Can I use a semi-automatic rifle for hunting?

A: You may use a semi-automatic rifle for hunting game that may be taken with a rifle. As of September 3, 2022, to take ownership of a semi-automatic rifle you must be at least 21 years old and must first apply for and acquire a New York State semi-automatic rifle license. A person of any legal hunting age may temporarily possess/borrow a legal semi-automatic rifle for hunting. Note, the SAFE Act also governs the features allowed for semi-automatic firearms and magazine capacity in all guns. Visit the "SAFE Act Resources for Hunters" website (safeact.ny.gov/resources-hunters) for a description of these features. Also note, rifles may not be used for hunting wild turkeys, pheasants, or migratory game birds (except crows).

Please contact your local Environmental Conservation Officers (ECOs) for answers to your specific questions (see pages 68–69).

Report Poachers and Polluters Hotline — 1-844-DEC-ECOS (1-844-332-3267)



ECOs Wing, Armstrong, and K9 Falcon with two seized deer in Chenango County.



ECO Hull with a seized buck in Oneida County.



Region 9 ECOs participate in a youth pheasant hunt in Genesee County.



ECO Johnson and Walraven with a seized bear hide in Ulster County.



ECO Holzle with an illegally shot raccoon in Niagara County.



ECO McCabe with a seized buck in Seneca County.

Environmental Conservation Officers

Report All Poachers and Polluters

1-844-DEC-ECOS (844-332-3267)

Approximately 250 field ECOs patrol the entire state. Their job includes enforcement of fish and wildlife laws and state environmental quality laws. ECOs rely on the eyes and ears of our dedicated members of the sporting community to report suspected violations. Poachers and other violators are stealing from you, your children, and our environment.

As soon as possible, call the hotline to report suspected violations. Dispatchers will assist you in filing a complaint. You may ask to have your name kept confidential or file anonymously.

Complaints are forwarded to an ECO for investigation. The sooner you call and the more detailed information you provide, the more likely the violator will be apprehended. Try to remember the “who, what, when, where, and how” of the event.

Keep your distance. Do not approach or confront suspects. They may be dangerous, destroy evidence, or simply evade officers if forewarned.

Who did it? Provide names, age, sex, height, weight, clothing, or vehicle descriptions, etc.

What occurred? What exactly is the nature of the violation? Examples — taking deer using bait, over limit, shooting from roadway, trespass, using tags of another, after hours, non-resident buying a resident license.

When did it occur? Dates and times. Is it still in progress, ongoing, or yet to happen?

Where did it occur? Provide exact street addresses, town/county, GPS locations, or other ways the officer can locate the scene, suspects, and evidence.

How did it occur? What methods or circumstances were used in the violation?

Interstate Wildlife Violator Compact

New York State is a member of IWVC, which is an agreement between 47 states to share information regarding hunting, fishing, and trapping convictions.

The IWVC gives members the capability to honor each other's license revocations so a violator convicted in one state may be barred from hunting, fishing, or trapping in all member states, at the discretion of each state.

Call NYSDEC Law Enforcement at 518-402-8816 or visit wildlifecrimestoppers.org.

Albany		
Lt. Jason DeAngelis	(518) 357-2047	
Bevis, Kyle	(518) 626-1541	
Hameline, Michael	(518) 339-7403	
Swan, Kurt	(518) 869- 5237	
Allegany		
Lt. RJ Ward	(716) 851-7050	
Calanni, Jr., Russell	(585) 403-2437	
Oliver, Dustin	(607) 590-1135	
Bronx		
Lt. Keith Levanway	(718) 482-4885	
Korey, Joan	(929) 895-2313	
Broome		
Lt. Anthony Rigoli	(315) 426-7431	
McCormick, Andrew	(607) 621-3464	
Templeton, Eric	(607) 621-3255	
Cattaraugus		
Lt. Liza Bobseine	(716) 851-7050	
Nosal, Robert	(716) 532-0461	
Powers, Jason	(716) 771-8266	
Cayuga		
Lt. Mark Colesante	(315) 426-7431	
Sincebaugh, Scott	(315) 253-8534	
Prentice, Zachary	(315) 404-6185	
Chautauqua		
Lt. Liza Bobseine	(716) 851-7050	
Mead, Nathaniel	(716) 548-1482	
Freeman, Christopher	(716) 490-3947	
Kinney, Jerry	(716) 401- 1187	
Chemung		
Lt. Matt Lochner	(315) 836-6137	
Dalecki, Erik	(607) 592-2783	
Lifrieri, John	(607) 644-3815	
Chenango		
Lt. Matthew Foster	(315) 426-7431	
Wing, Ryan	(607) 242-9156	
Armstrong, Brett	(607) 895-6515	
Plows, Daniel	(607) 221-6077	
Clinton		
Lt. Geoffrey Younglove	(518) 897-1200	
Lagree, Christopher	(518) 319-7706	
Fadden, Jeremy	(518) 912-4579	
LaCroix, Matthew	(518) 335-5422	
Columbia		
Lt. Walt Maloney	(518) 357-2047	
Cox, Jeffrey	(518) 794-8935	
Cortland		
Lt. Matthew Foster	(315) 426-7431	
Burdick, Matthew	(315) 251-0125	
Kostuk, Andrew	(315) 741-2205	
Delaware		
Lt. Anthony Glorioso	(518) 357-2047	
Osborne, Dustin	(607) 206-0711	
Doig, Nathan	(607) 267-5452	
Bauer, Vernon	(845) 346-6607	
Woodin, Jared	(607) 437-6259	
Dutchess		
Lt. Christopher Lattimer	(845) 256-3013	
Read III, Deo	(845) 240-6758	
Wamsley, Kevin	(914) 263- 7819	
Helmeier, John	(914) 474-5244	
Erie — Northern		
Lt. Nathan VerHague	(716) 851- 7050	
Gill, Carlton	(716) 908-5051	
Wilson, Charles	(716) 675-1095	
Powers, Jamie	(716) 604-5353	
Erie — Southern		
Lt. RJ Ward	(716) 851- 7050	
Bobseine, Ike	(631) 461-6061	
Machnica, Timothy	(716) 262-7411	
Damrath, Donald	(716) 261-5112	

Essex		
Lt. Stephen Gonyeau	(518) 897-1200	
Buffa, Bradley	(518) 354-0539	
Hovey, Jeffrey	(518) 354-9014	
Dewey, Sean	(518) 653-3077	
Nicols, Maxwell	(518) 338-2908	
Franklin		
Lt. Geoffrey Younglove	(518) 897-1200	
Riggs, Kevin	(518) 335-3558	
Okonuk, Jennifer	(518) 319-0064	
Favreau, Nathan	(518) 354-9833	
Fulton		
Lt. Matt Clemens	(518) 897-1200	
Manns, Shane	(518) 708-1168	
Pasciak, Paul	(518) 448-3103	
Genesee		
Lt. Shea Mathis	(585) 226-6706	
Fuerch, Fay	(585) 245-4975	
Laczi, Evan	(585) 208-3571	
Greene		
Lt. Anthony Glorioso	(518) 357-2047	
Palmateer, Lucas	(518) 478-1698	
Smith, Jason	(518) 703-3529	
Hamilton		
Lt. Robert Higgins	(518) 897-1200	
Pierce, Scott	(518) 866-4723	
Newell, Jared	(518) 257-9690	
Herkimer — North		
Lt. Aaron Markey	(315) 785-2231	
Gates, John	(315) 816-1449	
Noyes, Spencer	(315) 240-8862	
Tabor, Benjamin	(315) 214-9681	
Herkimer — South		
Lt. Aaron Markey	(315) 785-2231	
Jakub, Katie	(315) 269-7443	
Jefferson		
Lt. Steven Bartoszewski	(315) 785-2231	
Jackson, Peter	(315) 418-7380	
McFee, Evan	(315) 640-0335	
Woyton, Max	(315) 200-0813	
Rockefeller, Sean	(315) 200-0813	
Nicholas, Nicholas	(315) 466- 4931	
Kings		
Lt. Waldemar Auguscinski	(718) 482-4885	
Rappold, Justin	(929) 493-8231	
Kortz, Abigail	(929) 598-5860	
Lewis		
Lt. Steven Bartoszewski	(315) 785-2231	
Jarecki, Joshua	(315) 263-5987	
Kraeger, Shana	(315) 767-5232	
Worden, Timothy	(315) 778-9279	
Livingston		
Lt. Shea Mathis	(315) 836-6137	
Dussault, Shawn	(585) 362-0395	
Rauscher, Richard	(585) 300-7715	
Ward, Chris	(585) 303-0098	
Madison		
Lt. Matthew Foster	(315) 426-7431	
Grisolini, Ricardo	(607) 316-2574	
Monroe		
Lt. Timothy Fay	(585) 226-6706	
Dobies, Shane	(585) 329-8377	
Jankowski, Jacob	(585) 269-9338	
Johnston, Jeffrey	(585) 397-2746	
Lutz, John	(585) 303-1506	
Muchow, Adam	(585) 329-9381	
Snowdon, Thomas	(585) 683-6758	
Montgomery		
Lt. Jason DeAngelis	(518) 357-2047	
Valenty, Chris	(518) 505-4104	
Willson, Brian	(518) 491-2273	

Environmental Conservation Officers

Nassau	
Lt. Michael Unger	(631) 444-0250
Carpenter, Emma	(516) 260-3240
Brussell, Christine	(929) 505-4747
McCarthy, Brent	(929) 505-6877
Dickson, Brendan	(646) 634-9219
Michalet, Shawn	(929) 505-6878
Kochanowski, Zachary	(315) 748-8041
Pabes, Lawrence	(929) 505-6884
Smith, Bradley	(646) 629-0054
New York	
Lt. Keith Levanway	(718) 482-4885
Goonan, Christopher	(917) 636-3880
Ableson, Tyler	(929) 895-2307
Niagara	
Lt. Nathan VerHague	(716) 851-7050
Holzle, Kevin	(716) 454-2623
Scheer, George	(716) 377-2448
Wolgast, Joshua	(716) 243-9038
Oneida — North	
Lt. Aaron Markey	(315) 785-2231
Gates, John	(315) 816-1449
Noyes, Spencer	(315) 240-8862
Tabor, Benjamin	(315) 214-9681
Oneida — South	
Lt. Aaron Markey	(315)785-2231
Hull, Jeff	(315) 408-7179
Lakeman, Steven	(315) 734-0648
Starczek, Chrisman	(315) 489-4224
Howe, Robert	(315) 382-0996
Onondaga	
Lt. Mark Colesante	(315) 426-7431
Thomas, David	(315) 236-0307
Yacavone, Scott	(315) 487-4401
Scalisi, Heather	(315)412-5110
Ontario	
Lt. Kevin Thomas	(585) 226-6706
Blanton, Paul	(585) 694-4077
Brown, Timothy	(607) 227-8538
Orange	
Lt. Michael Bello	(845) 256-3013
Schneider, Joshua	(929) 505-6891
Schuck, Dylan	(929) 505-6892
Lovgren, Erik	(929) 505-6875
Orleans	
Lt. Shea Mathis	(585) 226-6706
Fonda, Vernon	(585) 735-6963
Godson, Nathan	(585) 441-4015
Oswego	
Lt. William Burnell	(315) 426-7431
Dorrett, Matthew	(315) 625-4129
Brown, Zachariah	(315) 200-2111
Grogan, Ryan	(315) 726-5227
Wozniak, Michael	(315) 418-6791
Bonilla, Aaron	(315) 382-3365
Otsego	
Lt. Michael Terrell	(518) 357-2047
Card, Timothy	(607) 267-9547
Fetterman, Russell	(607) 422-8342
Vencak, Mark	(607) 221-1544
Putnam	
Lt. Dustin Dainack	(845) 256-3013
Swansen, Chloe	(914) 260-6020
Franz, Daniel	(929) 505-6873
Tompkins, Craig	(845) 216-4628
Queens	
Lt. Christopher Macropoulos	(718) 482-4885
Parmelee, Brennan	(929) 505-6888
Swart, Brandon	(917) 636-2436
Milliron, Darren	(929) 505-6879
Keegan, Frank	(917) 636-2279

Rensselaer	
Lt. Walt Maloney	(518) 357-2047
Crain, Zachary	(518) 424-5343
Bush, Kurt	(518) 813-6805
Curinga, Jason	(518) 925-5549
Richmond	
Lt. Waldemar Auguscinki	(718) 482-4885
Farner, Kyle	(917) 636-2348
Clinger, Benjamin	(646) 369-0088
Rockland	
Lt. Michael Bello	(845) 256-3013
Boyes, Aric	(929) 505-2244
Lovgren, Erik	(929) 505-6875
Saratoga	
Lt. Matt Clemens	(518) 897-1200
Doroski, Jordan	(518) 788-8544
Klein, Mark	(518) 892-9402
Shaw, Steven	(518) 860-6875
Leubner, J. Wesley	(518) 729-8313
Schenectady	
Lt. Jason DeAngelis	(518) 357-2047
Valenty, Chris	(518) 505-4104
Willson, Brian	(518) 491-2273
Schoharie	
Lt. Michael Terrell	(518) 357-2047
Bohling, Justanna	(518) 443-9156
Burgess, Melissa	(518) 603-2446
Schuyler	
Lt. Matt Lochner	(315) 836-6137
Dalecki, Erik	(607) 592-2783
Lifrieri, John	(607) 644-3815
Seneca	
Lt. Kevin Thomas	(585) 226-6706
McCabe, Robert	(631) 494-5229
St. Lawrence	
Lt. Troy Basford	(315) 785-2231
Ryan, Jonathan	(315) 322-5106
Helmer, Ian	(315) 559-8503
Schneller, Joel	(315) 566-9258
Sherry, Michael	(315) 566-9574
Canary, Bret	(315) 489-3180
Munn, Joseph	(315) 842-2854
Atwood, Scott	(315) 262-2304
Steuben	
Lt. Matt Lochner	(315) 836-6137
Baker, Matthew	(607) 281-5435
Farrand, Steven	(607) 331-7549
Suffolk — Eastern	
Lt. Christopher Amato	(631) 444-0250
Kaufherr, Robert	(718) 683-7486
Small, April	(929) 505-6894
Cacciola, Garrett	(929) 505-6587
Day, Timothy	(347) 461-0183
Anderson, Stephanie	(929) 505-1174
Paschke, Connor	(929) 505-6889
Perkins, Nicholas	(929) 505-6890
DeRose, Christopher	(631) 601-5284

Suffolk — Western	
Lt. Thomas Gadomski	(631) 444-0250
Zullo, Emilio	(917) 636-2344
DeVito, Laura	(347) 533-0175
McGhee, Justin	(929) 598-5872
Vandenbos, Nicholas	(929) 493-8055
Della Rocco, Taylor	(347) 308-4589
Sullivan	
Lt. Michael Buckley	(845) 256-3013
Parker, Glen	(929) 505-6887
Wood, Ricky	(845) 665-5637
Doroski, Christopher	(929) 505-6869
Tioga	
Lt. Anthony Rigoli	(315) 426-7431
Wilson, Brent	(607) 972-4435
Tompkins	
Lt. Anthony Rigoli	(315) 426-7431
Eisenberg, Osman	(607) 564-9458
Krueger, Jeffrey	(607) 227-9584
Ulster	
Lt. Christopher Lattimer	(845) 256-3013
Walraven, Jonathon	(845) 281-3408
Johnson, Adam	(845) 587-6397
Chomicki, William	(845) 490-0875
Franco, Mary	(607) 244-4561
Warren	
Lt. Robert Higgins	(518) 897-1200
Brassard, Alan	(518) 409-6299
LaPoint, George	(518) 793-3767
Gerrain, Louis	(518) 925-5560
Washington	
Lt. Stephen Gonyeau	(518) 897-1200
Thibodeau, Matthew	(518) 605-4932
Krug, Matthew	(518) 417-9954
Wayne	
Lt. Kevin Thomas	(585) 226-6706
Rich, John	(585) 478-3505
Westchester	
Lt. Dustin Dainack	(845) 256-3013
Swansen, Chloe	(914) 260-6020
Franz, Daniel	(929) 505-6873
Tompkins, Craig	(845) 216-4628
Wyoming	
Lt. RJ Ward	(716) 851-7050
Koepf, Thomas	(716) 345-4252
Yates	
Lt. Matt Lochner	(315) 836-6137

Marine Enforcement Unit (MEU)		
County	Name	Number
MEU- Nassau/ Suffolk	Lt. Sean Reilly	(631) 444-0250
MEU- Nassau/ Suffolk	Giarratana, Casey	(929) 493-8079
MEU- Nassau/ Suffolk	Hilton, Derek	(929) 493-8241
MEU- Nassau/ Suffolk	Simmons, Landon	(631) 205-0470
MEU- New York City	Lt. Waldemar Auguscinki	(718) 482-4885
MEU- New York City	Pansini, Paul	(929) 505-6886
MEU- New York City	Veloski, Joshua	(929) 505-6896
MEU- New York City	Currey, Shane	(929) 505-6868
MEU- New York City	Traynor, Loren	(929) 505-6895
MEU- New York City	Broughton, Michael	(646) 916-0541

ECO Dispatch — 1-844-332-3267 for General Questions

Regional Maps

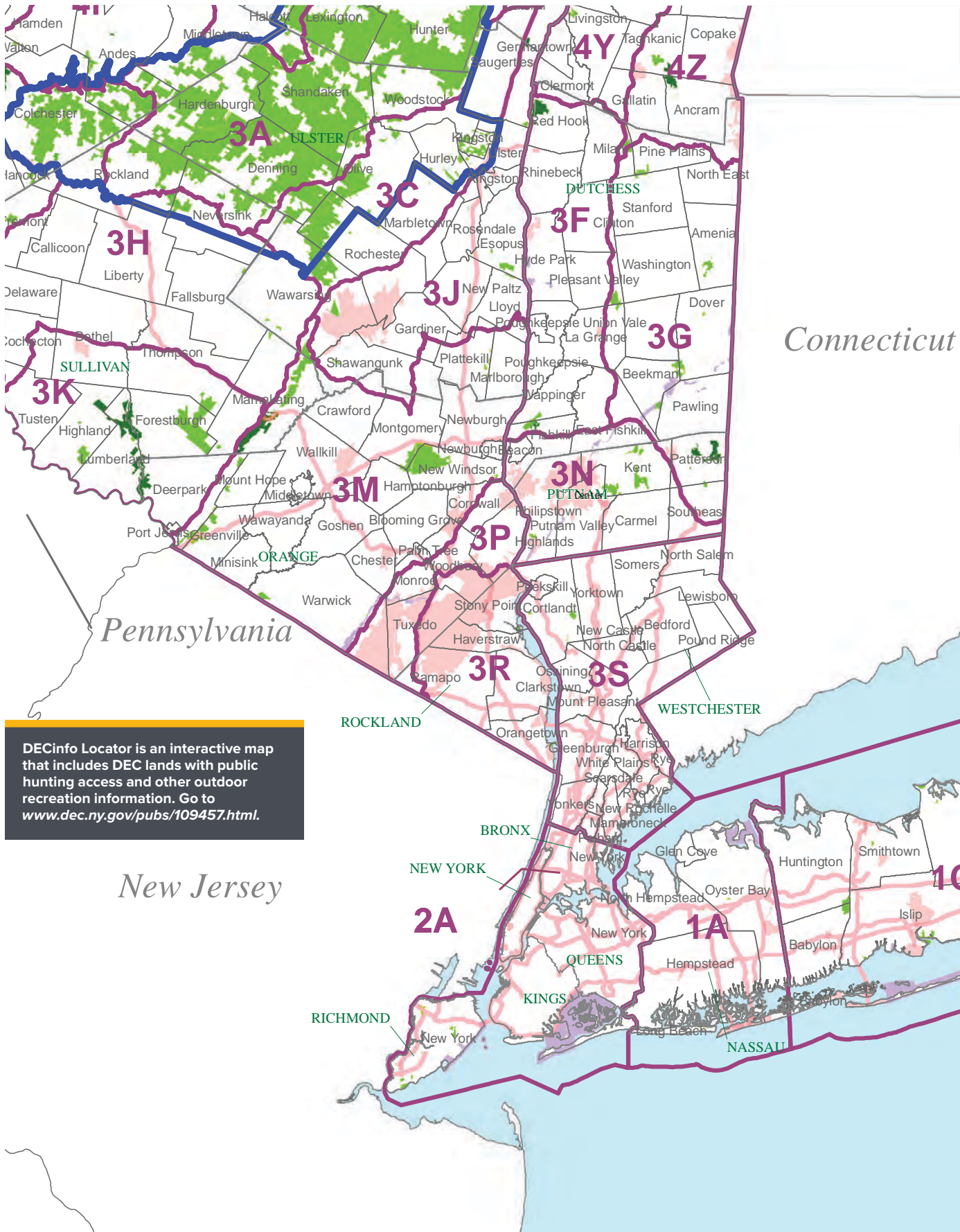

DECinfo Locator is an interactive map that includes DEC lands with public hunting access and other outdoor recreation information. Go to www.dec.ny.gov/pubs/109457.html.

WMA Accessible Features for Regions 1 and 3

Suffolk

Edgewood Oak Brush Plains Preserve (Babylon, Huntington, Islip)

- 1.7 mi CP-3 trail*

Otis Pike Preserve (Riverhead, Brookhaven)

- Accessible Blind, Parking

Randall Pond, Ridge Conservation Area (Ridge)

- Fishing Access, Parking, Permit Station, Restroom, Viewing Area, Viewing Platform, 2.1 mi foot trails

Sullivan/Orange

Bashakill WMA (Mamakating, Deerpark)

- Blind, Fishing Access, Parking

Mongaup Valley WMA (Forestburgh, Highland, Lumberland, Deerpark)

- Eagle Blind, Parking, Restroom

* CP-3 - Motorized Access Program for People with Disabilities. Go to www.dec.ny.gov/outdoor/2574.html for application instructions and forms.

Did you know, in 2022 DEC Forest Rangers:

- Patrolled 22,612 miles of trails by foot.
- Patrolled 2,610 miles of interior boundary line.
- Participated in 331 public outreach events.
- Conducted 349 search and rescue missions.

www.dec.ny.gov/regulations/41086.html

1-833-NYS-RANGERS (1-833-697-7264)



10 HIKING ESSENTIALS

Carry these essentials on all hikes for a safe and enjoyable experience.

- 1 **NAVIGATION** – map, compass, GPS system, extra batteries
- 2 **INSULATION** – waterproof/windproof jacket, hat, gloves, thermals, wool socks. Pack extra in case you get wet.
- 3 **LIGHT** – headlamp, flashlight, lanterns, extra batteries
- 4 **FIRST-AID SUPPLIES** – use a pre-made kit or build your own.
- 5 **EMERGENCY KIT** – whistle, signal mirror, duct tape, pocket knife/multi-tool, etc.
- 6 **FIRE** – matches in waterproof container, lighter, fire starters
- 7 **NUTRITION** – choose high-protein and high-calorie items, and be sure to pack extra food.
- 8 **WATER** – carry more than you think you need and a water filtration system.
- 9 **SUN PROTECTION** – sunglasses, sunscreen, hat
- 10 **EMERGENCY SHELTER** – tent, space blanket, tarp

★ **CARRY OUT WHAT YOU CARRY IN!**



NEW YORK STATE

Department of Environmental Conservation



STATE OF NEW YORK RANGER

IN AN EMERGENCY, CALL: 911

833-NYS-RANGERS (833-697-7264)
<http://on.ny.gov/NYSForestRangerRoster>
 Cell service not available in all areas.

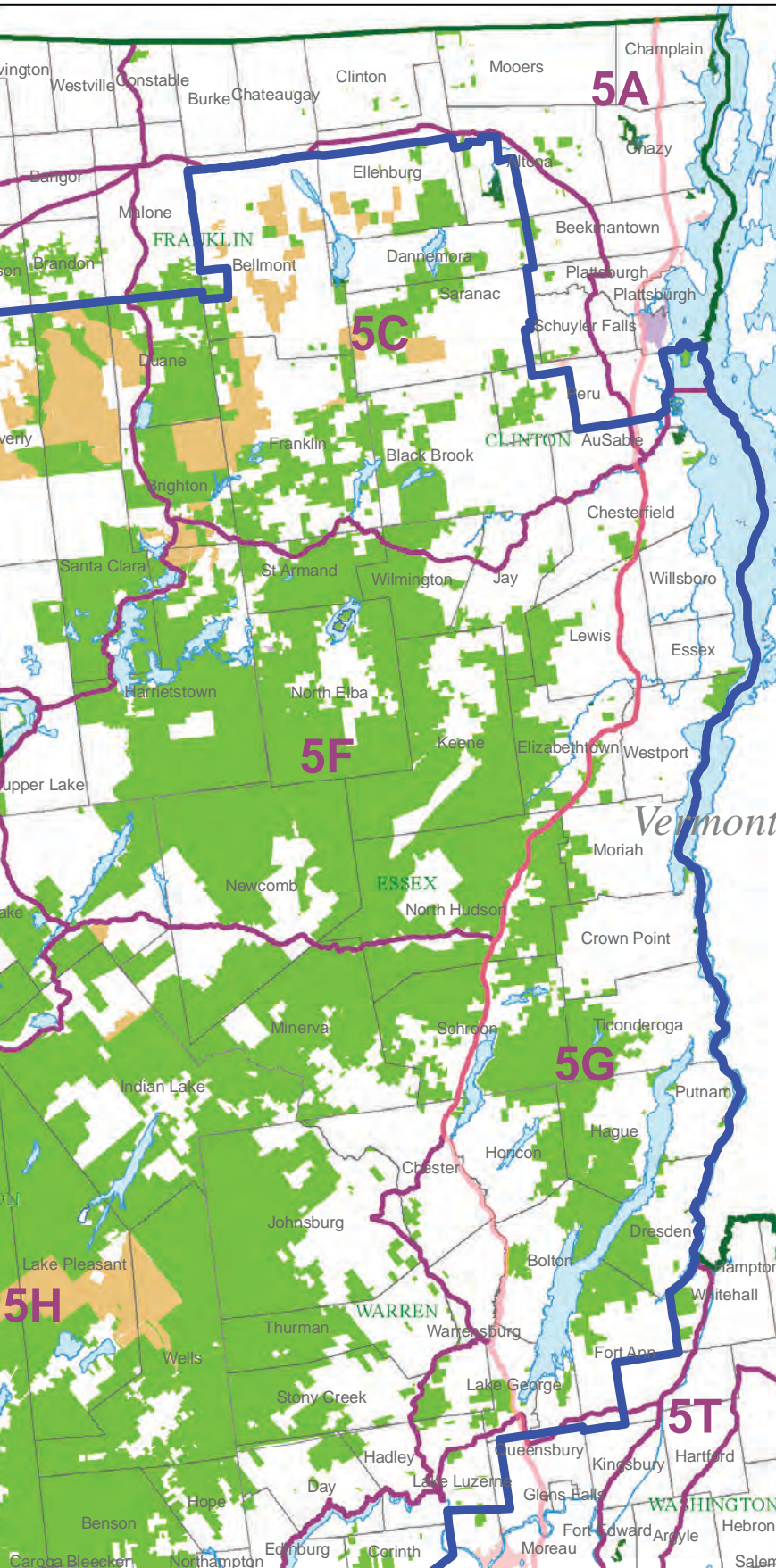

WMA Accessible Features for Regions 5 and 6

Clinton
Ausable Marsh WMA (Peru)
• Parking, Viewing Platform
Lake Alice WMA (Chazy)
• 0.4 mi CP-3 trail*, Parking, Blind, Fishing Access
Kings Bay WMA (Champlain)
• Parking, Viewing Platform
Essex
Wickham Marsh WMA (Chesterfield)
• Parking, Viewing Platform, 0.1 mi foot trail
Jefferson
Ashland Flats WMA (Lyme)
• Parking, Observation Tower
Black Pond WMA (Ellisburg)
• Fishing Access, Parking, Viewing Platform, 0.3 mi foot trail, 0.88 mi CP-3 trail
Lakeview WMA (Ellisburg)
• Fishing Access, Parking, Restroom, 0.6 mi foot trails
Perch River WMA (Orleans, Pamela, Brownville)
• Parking
Saratoga
Saratoga Sand Plains WMA Archery Range (Wilton)
• Parking
St. Lawrence
Upper & Lower Lakes WMA (Canton)
• Portable Blind Pads, Parking, 0.5 mi foot trails, Viewing Area
Wilson Hill WMA (Louisville)
• Parking, Blind, Boardwalk, Viewing Platform, 1.2 mi foot trails
Washington
Carters Pond WMA (Greenwich)
• Parking, Viewing Platform, 0.2 mi. foot trail
East Bay WMA (Whitehall)
• Parking, 0.1 mi Path, Viewing Platform
Washington Co. Grasslands WMA (Fort Edward)
• Parking, Viewing Platform

* CP-3 - Motorized Access Program for People with Disabilities. Go to www.dec.ny.gov/outdoor/2574.html for application instructions and forms.

Conservation Easements

Public hunting and trapping is allowed on the conservation easements shown on these maps, but because rules and regulations are different for each conservation easement, members of the public wishing to hunt or trap on a particular easement property are strongly encouraged to contact the local DEC office (see page 6) before planning a trip.

For more information on conservation easements, visit: www.dec.ny.gov/lands/41156.html.

Regional Maps

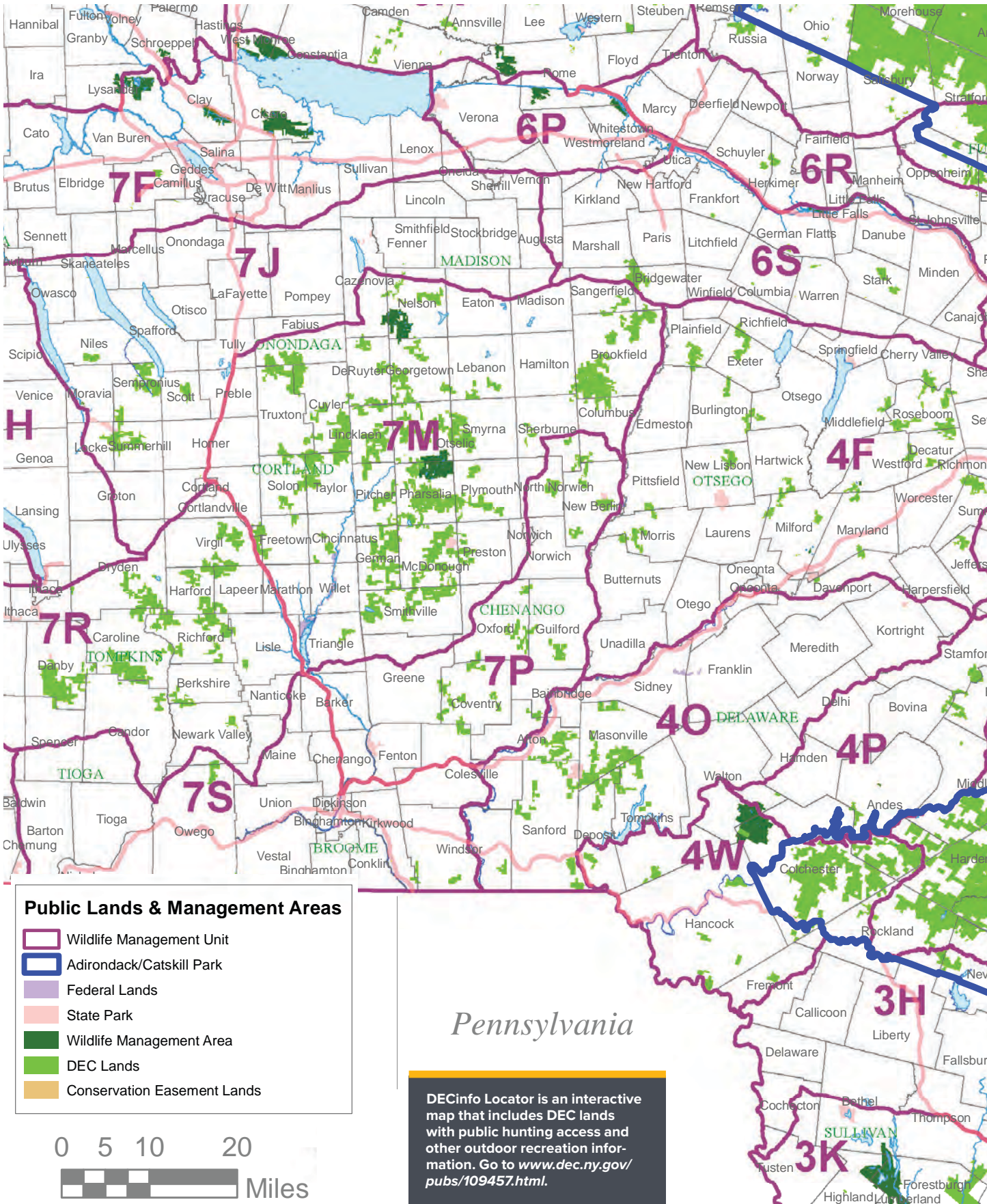

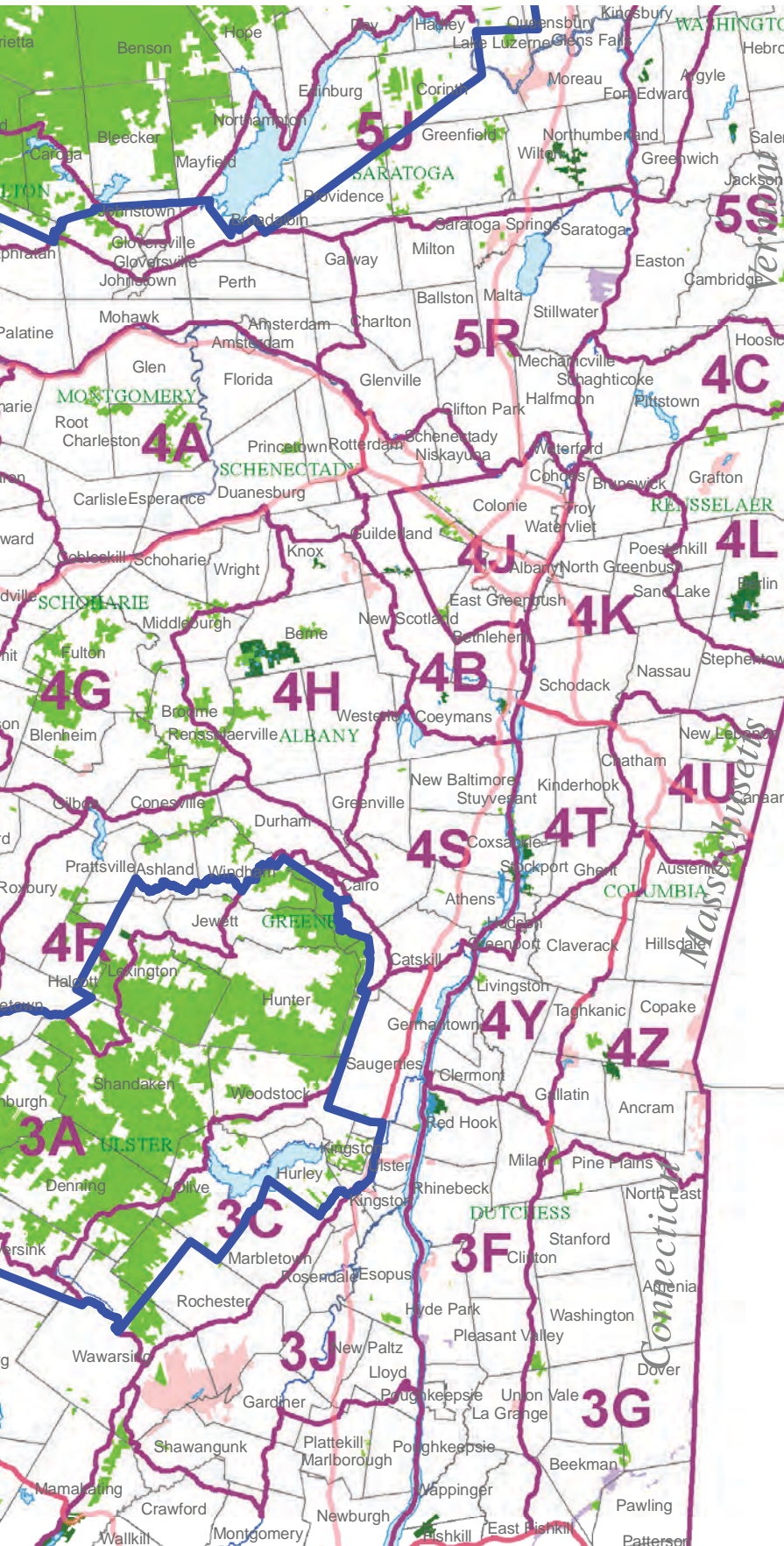

WMA Accessible Features for Regions 4 and 7

Albany
Partridge Run WMA (Berne)
<ul style="list-style-type: none"> CP-3 — Motorized Access Program for People with Disabilities. Go to www.dec.ny.gov/outdoor/2574.html for application instructions and forms.
Delaware
Bear Spring Mountain WMA (Walton)
<ul style="list-style-type: none"> CP3 trails
Greene
Vosburgh Swamp WMA (Coxsackie, Athens)
<ul style="list-style-type: none"> Accessible Blind, Boardwalk, Parking
Onondaga
Hamlin Marsh WMA (Clay)
<ul style="list-style-type: none"> Boardwalk, Parking, Viewing Platform, Blind, 0.1 mi foot trail
Three Rivers WMA (Lysander)
<ul style="list-style-type: none"> Parking, Viewing Platform, Blind, 0.2 mi gravel foot trail
Oswego
Deer Creek Marsh WMA (Richland)
<ul style="list-style-type: none"> Seasonal Hand Launch (May-October), Parking, 0.1 mi foot trail
Rensselaer
Capital District WMA (Stephentown and Berlin)
<ul style="list-style-type: none"> CP3 trails
Schoharie
Franklinton Vlaie WMA (Broome)
<ul style="list-style-type: none"> Parking, Viewing Pavilion, Viewing Site, Fishing Access

FIREWOOD WARNING

Your firewood may be hiding invasive pests that are killing our trees and forever changing the forests we love. Protect our trees.

Buy Local, Burn Local.

- It is illegal to bring untreated* firewood into New York State
 - It is illegal to transport untreated firewood more than 50 miles from its source or origin
 - When transporting firewood, you must carry proof of source (receipt from a vendor), origin (self-issued certificate from DEC website), or treatment (label showing treatment method)
- * Treated firewood has been heated to 160°F for 75 minutes to eliminate pests living inside the wood. Treated firewood can be moved without restriction.

Failure to follow these regulations may result in a ticket.

For questions, call toll-free:
1-866-640-0652

State and federal quarantines exist that further restrict the movement of firewood. For more information, visit www.dec.ny.gov and search for "invasive insects".



Department of Environmental Conservation



ASIAN LONGHORNED BEETLE

EMERALD ASH BORER

Regional Maps



DECinfo Locator is an interactive map that includes DEC lands with public hunting access and other outdoor recreation information. Go to www.dec.ny.gov/pubs/109457.html.



Map produced by NYSDEC KFB, 3/26/2020

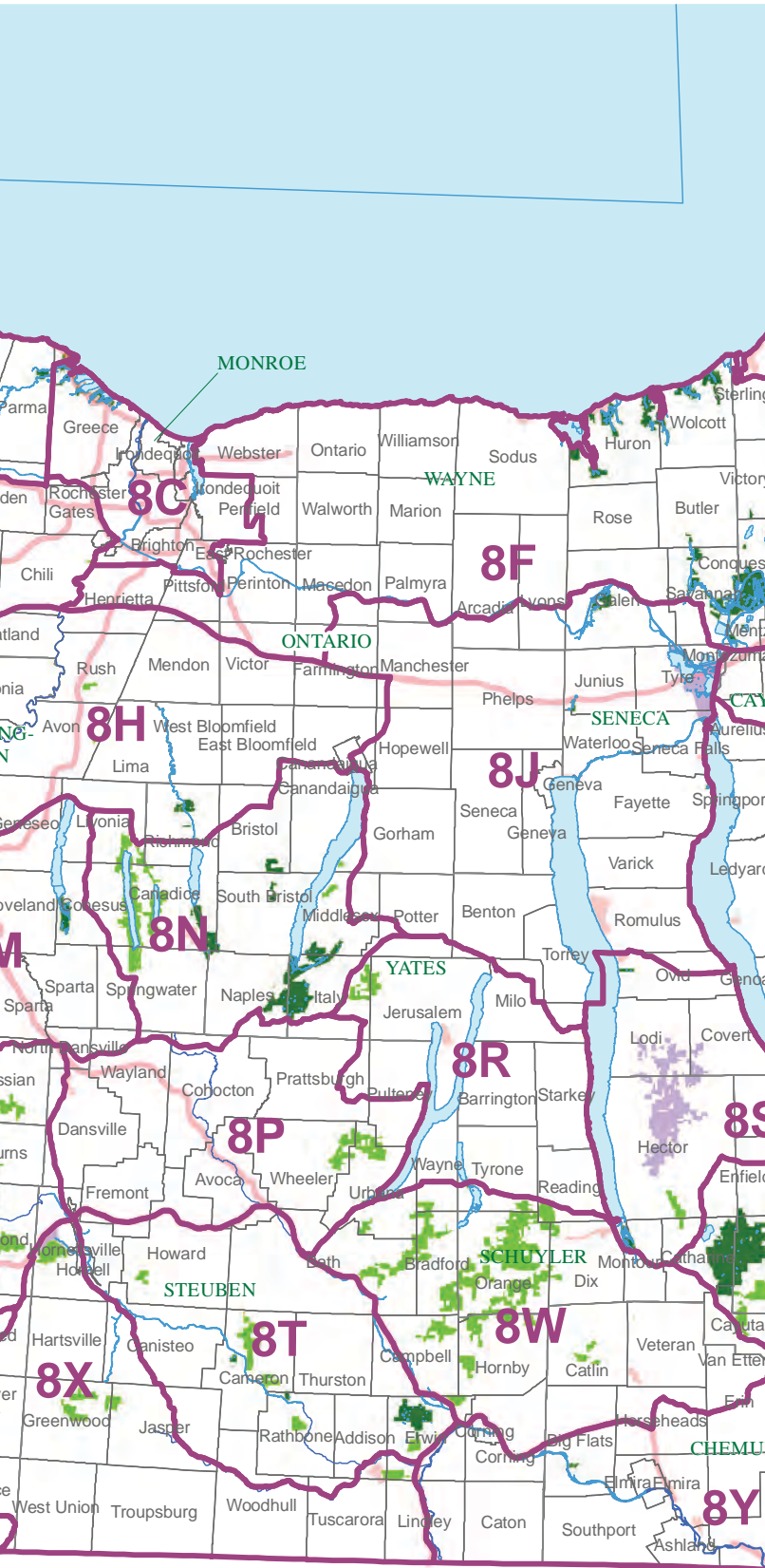

WMA Accessible Features for Regions 8 and 9

Allegany
Hanging Bog WMA (New Hudson)
• CP-3 trail
Cattaraugus
Birch Run Ponds FWMA (Allegany)
• Fishing Access, Parking, 0.3 mi foot trail
Harwood Lake MUA (Farmersville)
• Parking
Cattaraugus/Erie
Zoar Valley MUA (Otto, Persia, Collins)
• Parking, Parking Area, Short Trail, Viewing Platform
Cayuga/Wayne/Seneca
Northern Montezuma WMA (Victory, Conquest, Mentz, Montezuma, Butler, Savannah, Seneca Falls)
• Parking, Restroom, Viewing Platform, 1.4 mi foot trails
Chautauqua
Chautauqua Lake FWMA (Ellery, North Harmony)
• Parking, Blind/Viewing Platform, 0.2 mi foot trail
Watts Flats (Harmony)
• Parking, Viewing Platform
Erie
Great Baehre Swamp WMA (Amherst)
• Parking, Boardwalk
Spicer Creek WMA (Grand Island)
• Accessible Blind, Parking, 0.4 mi foot trail
Tillman Road WMA (Clarence)
• Boardwalk, Parking, Viewing Platform, 0.1 mi foot trail
Genesee
John White WMA (Alabama)
• Accessible Blind, Parking, 0.62 mi CP-3 trail
Livingston
Conesus Inlet WMA (Conesus)
• Parking, 0.1 mi foot trail, Viewing Area, 1mi CP-3 trail
Livingston/Allegany
Rattlesnake Hill WMA (Nunda, Ossian, Grove)
• Viewing Platform, Parking, 9.3 mi CP-3 trails
Monroe
Braddock Bay WMA (Parma, Greece)
• Fishing Access, Parking, Viewing Platform, Kayak Launch
Ontario
Honeoye Creek WMA (Richmond)
• 2.8 mi CP-3 trails
Ontario/Yates
High Tor WMA (Naples, Italy Middlesex)
• Fishing Access, Hand Launch, Parking, 8.4 mi CP-3 trails
Orleans/Erie/Niagara/Genesee
Tonawanda WMA (Shelby, Newstead, Royalton, Alabama)
• Accessible Blind, Parking, 0.2 mi foot trail
Orleans/Genesee
Oak Orchard WMA (Barre, Shelby, Oakfield, Alabama)
• Parking, Viewing Platform, Pavilion, 0.1 mi foot trail, 3.2 mi CP-3 trails
Schuyler
Catharine Creek WMA (Dix, Montour)
• 2 mi. CP-3 trail*
Waneta-Lamoka WMA (Tyrone)
• Hand Launch, Parking
Steuben
Erwin WMA (Erwin)
• Parking, 5.38 mi CP-3 trails
Wayne
Galen WMA (Galen)
• 2.2 mi CP-3 trails
Lake Shore Marshes WMA (Rochester, Oswego)
• Fishing Access, Hand Launch, Parking, Seasonal Restroom
Wyoming
Carlton Hill MUA (Middlebury)
• 0.6 mi CP-3 trail*

* CP-3 - Motorized Access Program for People with Disabilities. Go to www.dec.ny.gov/outdoor/2574.html for application instructions and forms.

